



Allgemeines Pumpe

Chemie-Normpumpen der Typenreihe N sind normal-saugende, einstufige, Kreiselpumpen aus Kunststoff in horizontaler Bauart und entsprechen in Abmessungen und Leistungsbereich DIN/EN 22858.

Pumpen dieser Typenreihe wurden den Anforderungen der chemischen Industrie entsprechend entwickelt und werden somit hauptsächlich zur Förderung von reinen oder feststoffdurchsetzten, sauren oder alkalischen, niedrigviskosen Flüssigkeiten eingesetzt.

Da die mit dem Fördermedium in Berührung kommenden Werkstoffe physiologisch unbedenklich sind, werden diese Pumpen auch in der Nahrungsmittelindustrie eingesetzt.

Der standardmäßige Einsatz von Ausbakupplungen gewährleistet den einfachen Ausbau von Lagerträger und Pumpeninnenteilen ohne Demontage der Rohrleitungsanschlüsse und des Motors. Dadurch entfällt das aufwendige Ausrichten der Pumpe und des Motors beim Zusammenbau des Aggregats.

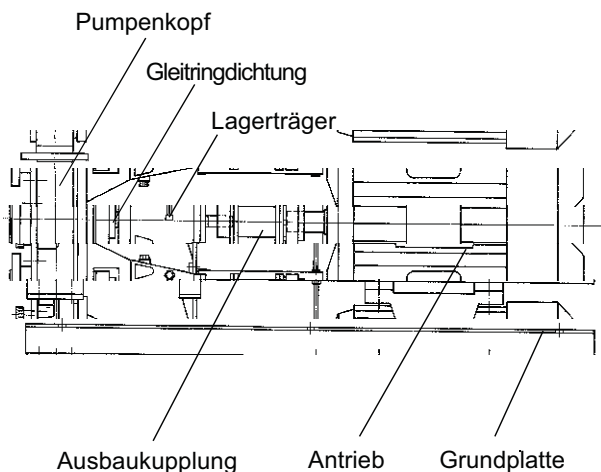

Pumpenkopf, Schaufelrad

Alle mit dem Medium in Berührung kommenden Teile sind aus hochwertigen Materialien wie PP, PVDF, Hartkohle, Elastomere aus EPDM oder FPM ausgeführt. Die außenliegenden metallischen Teile sind durch einen chemisch beständigen Schutzlack vor Korrosion geschützt. Bei allen Baugrößen werden geschlossene Schaufelräder mit Entlastungsbohrungen für den Axialschubausgleich eingesetzt. Die Drehmomentübertragung ist formschlüssig ausgeführt.



Stutzenstellung, Anschlüsse

Der Saugstutzen ist axial, der Druckstutzen radial nach oben angeordnet. Standardmäßig werden die saug- und druckseitigen Anschlüsse mit Flanschen, bzw. mit Stehbolzen für Flanschanschlüsse nach DIN 2501/PN 10 ausgeführt.

Welle und Lagerung

Die Lagerung der kräftig dimensionierten Edelstahlwelle erfolgt durch zwei öl bzw. fettgeschmierte Wälzlager im Lagerträger aus GG26.

Eine Wellenschutzhülse aus kunstharzimprägnierter Kohle (oder PVDF) schützt die Pumpenwelle vor dem Kontakt mit dem Fördermedium.

Wellenabdichtungen

Die Abdichtung der Wellendurchführung erfolgt durch wartungsfreie Gleitringdichtungen. Je nach Betriebsbedingungen werden innenliegende, einfach- oder doppeltwirkende Ausführungen eingesetzt. Doppeltwirkende Gleitringdichtungen erfordern eine Zuführung von Sperrflüssigkeit.

Gleitwerkstoffe aus Siliciumkarbid (SiC), Balg und Nebendichtungen aus EPDM oder FPM, metallische Teile aus Edelstahl (1.4571) oder Hastelloy C-4 (2.4610) sind Standardkombinationen und decken einen weiten Einsatzbereich ab.

Das Platzangebot im Dichtungsraum erlaubt den Einsatz handelsüblicher Dichtungsfabrikate. Sonderausführungen auf Anfrage.

Chemie-Normpumpe N

Grundplatte

Chemie-Normpumpen der Typenreihe N werden als komplette Gruppen bestehend aus Pumpe, Kupplung und Elektromotor, aufgebaut auf einer gemeinsamen Grundplatte aus Stahl, geliefert.

Antrieb

Oberflächengekühlte Drehstrommotoren nach IEC-Norm, 1450min⁻¹ bzw. 2900 min⁻¹, Schutzart IP 55, Isolationsklasse F, Bauform IM B3.

Pumpen-Nennleistungen nach DIN/EN 22 858

Pumpengröße N ...	Förderleistung bei 1450 min ⁻¹		Förderleistung bei 2900 min ⁻¹	
	Nennförderstrom [m ³ /h]	Nennförderhöhe [m]	Nennförderstrom [m ³ /h]	Nennförderhöhe [m]
50-32-125	8,3	5	12,5	20
50-32-160		8		32
50-32-200		12,5		50
50-32-250		20		80
65-40-125	12,5	5	25	20
65-40-160		8		32
65-40-200		12,5		50
65-40-250		20		80
65-40-315		32		100
80-50-125	25	5	50	20
80-50-160		8		32
80-50-200		12,5		50
80-50-250		20		80
80-50-315		32		100
100-65-125	50	5	100	20
100-65-160		8		32
100-65-200		12,5		50
100-65-250		20		80
100-65-315		32		100
125-80-160	80	8	160	32
125-80-200		12,5		50
125-80-250		20		80
125-80-315		32	---	---
125-100-200	125	12,5	---	---
125-100-250		20	---	---
125-100-315		32	---	---
150-125-250	200	20	---	---
200-150-250	315	10	---	---

Ausbaukupplung und Elektromotor

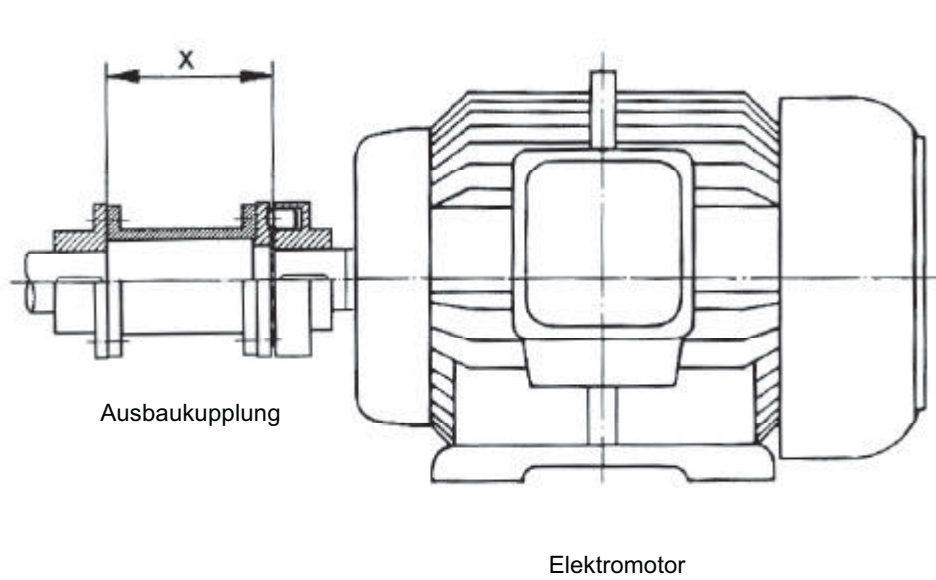

Ausbaukupplung N-EUPEX

Typ	Maß X [mm]	Bestell-Nr. Kupplung	Bestell-Nr. Satz Kupplungsgummi
H 80	100	51921	68430
H 95	100	51922	68431
	140	51923	68431
H 110	100	51924	68432
	140	51925	68432
H 125	100	51926	68433
	140	51927	68433
H 140	100	51928	68434
	140	51929	68434
H 160	140	51930	68435

Elektromotor

Drehstrommotor komplett, Bauform B3, nach IEC-Norm, 3x400 V / 50 Hz, Isolationsklasse F, Schutzart IP 55.

Leistung [kW]	Baugröße 1450min ⁻¹	Bestell-Nr.	Baugröße 2900min ⁻¹	Bestell-Nr.
0,55	80	78863	---	---
0,75	80	78864	80	78848
1,1	90S	78865	80	78849
1,5	90L	78866	90S	78850
2,2	100L	78867	90L	78851
3,0	100L	78868	100L	78852
4,0	112M	78869	112M	78853
5,5	132S	78870	132S	78854
7,5	132M	78871	132S	78855
11,0	160M	78872	160M	78856
15,0	160L	78873	160M	78857
18,5	180M	78874	160L	78858
22,0	180L	78875	180M	78859
30,0	200L	78876	200L	78860
37,0	225S	78877	200L	78861
45,0	225M	78878	225M	78862

Chemie-Normpumpe N

Maßbild, Pumpe kpl.

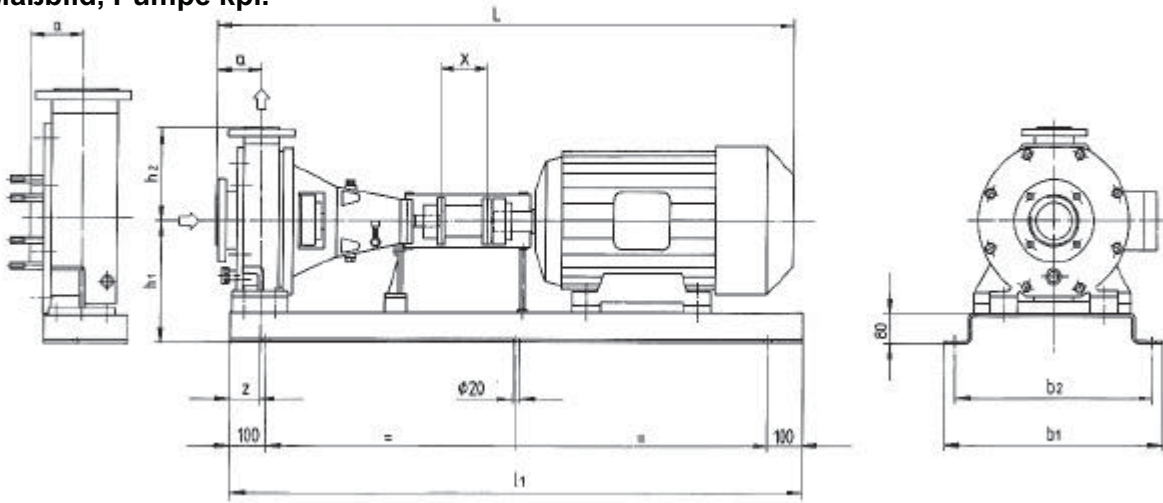

Pumpengröße N ...	Antriebsmotor 1450 min ⁻¹			Antriebsmotor 2900 min ⁻¹		
	max. Leistung [kW]	Motor Baugröße	*L	max. Leistung [kW]	Motor Baugröße	*L
50-32-125	1,5	90L	885	5,5	132S	1012
50-32-160	4,0	112M	946	11,0	160M	1148
50-32-200	4,0	112M	946	18,5	160L	1192
50-32-250	5,5	132S	1150	22,0	180M	1350
65-40-125	3,0	100L	1150	5,5	132S	1012
65-40-160	4,0	112M	946	15,0	160M	1148
65-40-200	5,5	132S	1150	22,0	180M	1350
65-40-250	11,0	160M	1170	37,0	200L	1485
65-40-315	11,0	160M	1170	37,0	200L	1485
80-50-125	3,0	100L	930	15,0	160M	1148
80-50-160	7,5	132M	1070	18,5	160L	1212
80-50-200	7,5	132M	1070	37,0	200L	1485
80-50-250	15,0	160L	1395	37,0	200L	1485
80-50-315	30,0	200L	1506	37,0	200L	1485
100-65-125	7,5	132M	1070	22,0	180M	1350
100-65-160	7,5	132M	1070	30,0	200L	1485
100-65-200	15,0	160L	1395	37,0	200L	1485
100-65-250	15,0	160L	1395	45,0	225M	1565
100-65-315	7,0	225S	1573	---	---	---
125-80-160	7,5	132M	1070	45,0	225M	1565
125-80-200	15,0	160L	1395	45,0	225M	1565
125-80-250	30,0	200L	1506	45,0	225M	1565
125-80-315	45,0	225M	1590	---	---	---
125-100-200	18,5	180M	1415	---	---	---
125-100-250	22,0	180L	1520	---	---	---
125-100-315	45,0	225M	1653	---	---	---
150-125-250	22,0	180L	1520	---	---	---
200-150-250	30,0	200L	1638	---	---	---

* bei max. Motorleistung

Maßbild, Pumpe kpl.

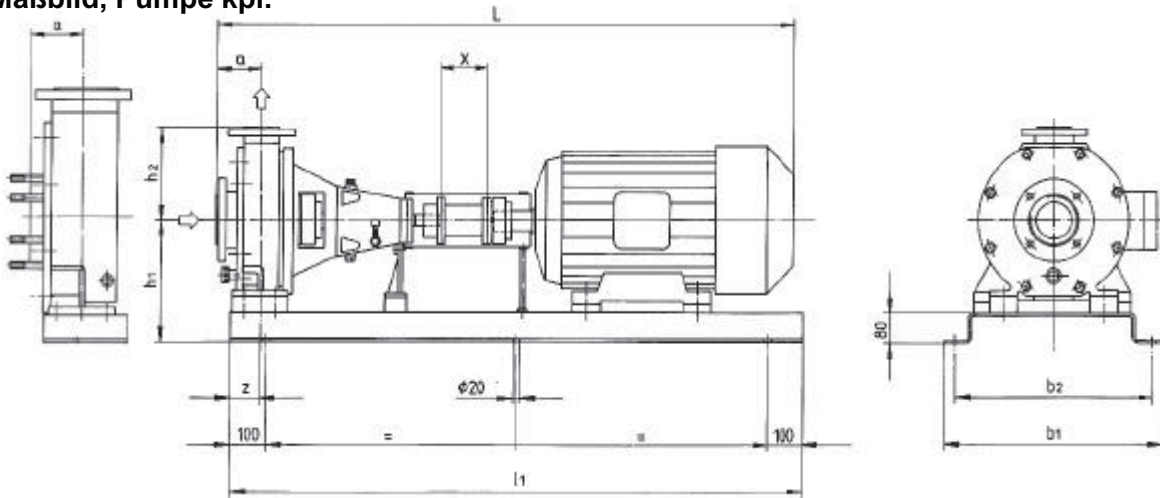

Pumpengröße N ...	Flanschschlußmaße nach DIN 2501, Teil 1 f. PN10		Pumpenmaße							
	DN _s Eintritt	DN _d Austritt	a	z	* l ₁	h ₁	h ₂	b ₁	b ₂	X
50-32-125	50	32	80	75	1000	192	140	430	370	100
50-32-160			80	75	1000	212	160	430	370	
50-32-200			80	75	1000	240	180	430	370	
50-32-250			100	87,5	1200	260	225	510	450	
65-40-125	65	40	80	75	1000	192	140	430	370	100
65-40-160			80	75	1000	212	160	430	370	
65-40-200			100	75	1000	240	180	430	370	
65-40-250			100	87,5	1200	260	225	510	450	
65-40-315			125	87,5	1200	280	250	510	450	
80-50-125	80	50	100	75	1000	212	160	430	370	100
80-50-160			100	75	1000	240	180	430	370	
80-50-200			100	75	1000	240	200	430	370	
80-50-250			125	87,5	1200	260	225	510	450	
80-50-315			125	87,5	1400	305	250	560	500	
100-65-125	100	65	100	87,5	1000	240	180	430	370	100
100-65-160			100	87,5	1200	240	200	510	450	
100-65-200			100	87,5	1400	260	225	560	500	140
100-65-250			125	105	1400	280	250	560	500	
100-65-315			125	105	1600	305	280	610	550	
125-80-160	125	80	125	87,5	1200	260	225	510	450	140
125-80-200			125	87,5	1400	260	250	560	500	
125-80-250			125	105	1600	305	280	610	550	
125-80-315			125	105	1600	330	315	610	550	
125-100-200	125	100	125	100	1400	280	280	560	500	140
125-100-250			140	100	1400	305	280	560	500	
125-100-315			140	100	1600	330	315	610	550	
150-125-250	150	125	140	100	1400	330	355	560	500	140
200-150-250	200	150	160	115	1600	360	375	610	550	180

* bei max. Motorleistung

Maßbild, Pumpekopf / Lagerträger kpl.

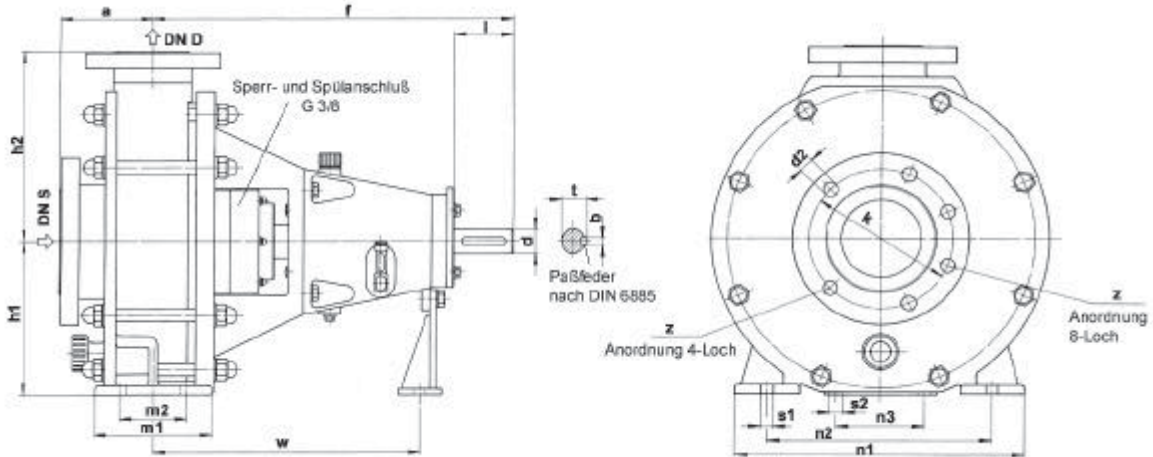

Pumpengröße N ...	Flanschanschlußmaße nach DIN 2501, Teil 1 f. PN10		Pumpenmaße				Wellenende DIN 748			
	DN _s Eintritt	DN _d Austritt	a	f	h1	h2	d	l	t	b
	50-32-125	50	32	80	385	112	140	24	50	27
50-32-160	80			385	132	160	24	50	27	8
50-32-200	80			385	160	180	24	50	27	8
50-32-250	100			500	180	225	32	80	35	10
65-40-125	65	40	80	385	112	140	24	50	27	8
65-40-160			80	385	132	160	24	50	27	8
65-40-200			100	385	160	180	24	50	27	8
65-40-250			100	500	180	225	32	80	35	10
65-40-315			125	500	200	250	32	80	35	10
80-50-125	80	50	100	385	132	160	24	50	27	8
80-50-160			100	385	160	180	24	50	27	8
80-50-200			100	385	160	200	24	50	27	8
80-50-250			125	500	180	225	32	80	35	10
80-50-315			125	500	225	280	32	80	35	10
100-65-125	100	65	100	385	160	180	24	50	27	8
100-65-160			100	500	160	200	32	80	35	10
100-65-200			100	500	180	225	32	80	35	10
100-65-250			125	500	200	250	32	80	35	10
100-65-315			125	530	225	280	42	110	45	12
125-80-160	125	80	125	500	180	225	32	80	35	10
125-80-200			125	500	180	250	32	80	35	10
125-80-250			125	500	225	280	32	80	35	10
125-80-315			125	530	250	315	42	110	45	12
125-100-200	125	100	125	500	200	280	32	80	35	10
125-100-250			140	530	225	280	42	110	45	12
125-100-315			140	530	250	315	42	110	45	12
150-125-250	150	125	140	530	250	355	42	110	45	12
200-150-250	200	150	160	530	280	375	42	110	45	12

Pumpekopf / Lagerträger kpl.

Pumpengröße N ...	Fußmaße							
	m1	m2	n1	n2	n3	f. Schrauben		w
						s1	s2	
50-32-125	100	70	190	140	110	M12	M12	285
50-32-160	100	70	240	190				285
50-32-200	100	70	240	190				285
50-32-250	125	95	320	250				370
65-40-125	100	70	210	160	110	M12	M12	285
65-40-160	100	70	240	190				285
65-40-200	100	70	265	212				285
65-40-250	125	95	320	250				370
65-40-315	125	95	345	280				370
80-50-125	100	70	240	190	110	M12	M12	285
80-50-160	100	70	265	212				285
80-50-200	100	70	265	212				285
80-50-250	125	95	320	250				370
80-50-315	160	95	345	280				370
100-65-125	125	95	280	212	110	M12	M12	285
100-65-160	125	95	280	212		M12		370
100-65-200	125	95	320	250		M12		370
100-65-250	160	120	360	280		M16		370
100-65-315	160	120	400	315		M16		370
125-80-160	125	95	320	250	110	M12	M12	370
125-80-200	125	95	345	250		M12		
125-80-250	160	120	400	315		M16		
125-80-315	160	120	400	315		M16		
125-100-200	160	120	360	280	110	M16	M12	370
125-100-250	160	120	400	315				
125-100-315	160	120	400	315				
150-125-250	160	120	400	315	110	M16	M12	370
200-150-250	200	150	500	400	110	M16	M12	370

Maßbild, Pumpekopf / Lagerträger kpl.

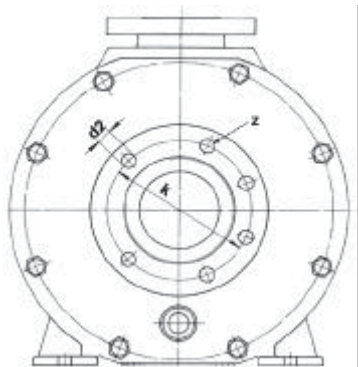

Flansche nach DIN 2501			
DN	k	d2	z
32	100	18	4
40	110	18	4
50	125	18	4
65	145	18	4
80	160	18	8
100	180	18	8
125	210	18	8
150	240	22	8
200	295	22	8

Zuordnung der Grundplatten und Kupplungen

Motor-Baugröße	80	90S	90L	100L	112M	132S	132M
Leistung [kW]							
2900min-1	0,75+1,1	1,5	2,2	3,0	4,0	5,5+7,5	-
1450min-1	0,55+0,75	1,1	1,5	2,2+3,0	4,0	5,5	7,5
Kupplungsgröße							
2900min-1	H80	H80	H80	H80	H80	H95	-
1450min-1	H80	H80	H80	H80	H80	H95	H95
Pumpen- / Grundplattengröße							
50-32-125	1	1	1	1	1	1	1
50-32-160	-	1	1	1	1	1	1
50-32-200	-	1	1	1	1	1	1
50-32-250	-	2	2	2	2	3	3
65-40-125	-	1	1	1	1	1	1
65-40-160	-	1	1	1	1	1	1
65-40-200	-	1	1	1	1	1	1
65-40-250	-	2	2	2	2	3	3
65-40-315	-	2	2	2	2	3	3
80-50-125	-	1	1	1	1	1	1
80-50-160	-	1	1	1	1	1	1
80-50-200	-	1	1	1	1	1	1
80-50-250	-	2	2	2	2	3	3
80-50-315	-	2	2	2	2	3	3
100-65-125	-	1	1	1	1	1	1
100-65-160	-	1	1	1	1	3	3
100-65-200	-	2	2	2	2	3	3
100-65-250	-	-	-	3	3	3	3
100-65-315	-	-	-	4	4	4	4
125-80-160	-	2	2	3	3	3	3
125-80-200	-	-	-	3	3	3	3
125-80-250	-	-	-	4	4	4	4
125-80-315	-	-	-	4	4	4	4
125-100-200	-	-	-	-	-	4	4
125-100-250	-	-	-	-	-	-	-
125-100-315	-	-	-	-	-	-	-
150-125-250	-	-	-	-	-	-	-
200-150-250	-	-	-	-	-	-	-

Andere Motorgrößen auf Anfrage

Zuordnung der Grundplatten und Kupplungen

Motor-Baugröße	160M	160L	180M	180L	200L	225S	225M
Leistung [kW]							
2900min-1	11,0+15,0	18,5	22,0	-	30,0+37,0	-	45,0
1450min-1	11,0	15,0	18,5	22,0	30,0	37,0	45,0
Kupplungsgröße							
2900min-1	H95	H95	H110	-	H125	-	H125
1450min-1	H95	H110	H110	H125	H125	H140	H140
Pumpen- / Grundplattengröße							
50-32-125	-	-	-	-	-	-	-
50-32-160	3	-	-	-	-	-	-
50-32-200	3	3	-	-	-	-	-
50-32-250	3	3	5	5	5	-	-
65-40-125	-	-	-	-	-	-	-
65-40-160	3	3	-	-	-	-	-
65-40-200	3	3	3	3	-	-	-
65-40-250	3	3	5	5	5	-	-
65-40-315	3	3	3	5	5	7	-
80-50-125	3	3	-	-	-	-	-
80-50-160	3	3	3	3	-	-	-
80-50-200	3	3	3	3	5	-	-
80-50-250	3	3	5	5	5	7	-
80-50-315	3	3	5	5	5	7	-
100-65-125	3	3	3	3	-	-	-
100-65-160	3	3	3	5	5	-	-
100-65-200	5	5	5	5	5	7	-
100-65-250	5	5	5	5	5	7	-
100-65-315	5	5	5	5	7	7	-
125-80-160	5	5	5	5	7	7	7
125-80-200	5	5	5	5	7	7	7
125-80-250	5	5	5	5	7	7	7
125-80-315	5	5	5	5	7	7	7
125-100-200	5	5	5	-	-	-	-
125-100-250	5	5	5	5	-	-	-
125-100-315	-	-	5	5	7	7	7
150-125-250	5	5	7	7	-	-	-
200-150-250	7	7	7	7	7	-	-

Andere Motorgrößen auf Anfrage

Gleitringdichtungen

Allgemein

Gleitringdichtungen bestehen in ihrer Grundform aus zwei absolut planen Flächen. Die eine Fläche rotiert mit der Welle, die andere ist stationär angeordnet. Die Dichtwirkung wird durch den unmittelbaren Kontakt der beiden planen Flächen erreicht. Der stationäre Gegenring ist üblicherweise fest eingebaut.

Der Gleitring wird axial und radial beweglich angeordnet, um die im Betrieb auftretenden Wellenauslenkungen ausgleichen zu können. Diese axiale Beweglichkeit ermöglicht den Einbau von Gleitringdichtungen innerhalb praktikabler Fertigungstoleranzen, wobei die erforderliche Genauigkeit von der Konstruktion der Gleitringdichtung abhängt.

Typ B2I

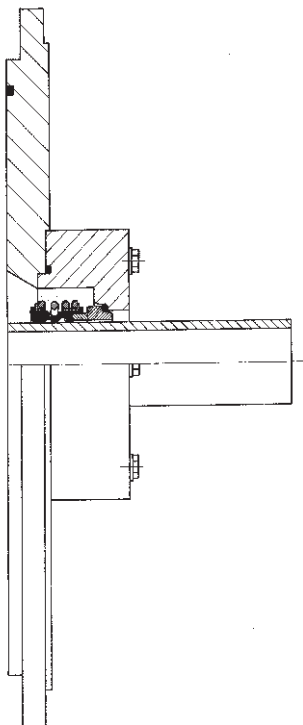

Einfachwirkend, belastet, innenliegend und drehrichtungsunabhängig.

Kombination der Gleitwerkstoffe in (SiC). Balgwerkstoffe und Nebendichtungen aus EPDM und FPM. Metallische Teile aus Edelstahl oder Hastelloy C-4.

Geeignet für: Einsatz bei neutralen und aggressiven Medien, welche nicht auskristallisieren und frei von Feststoffen sind.

Typ B2Q

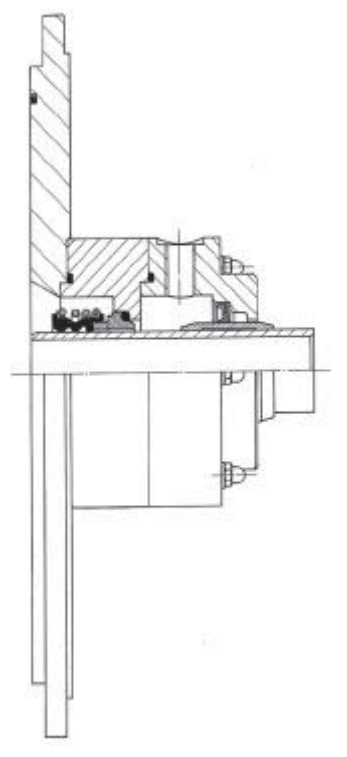

Einfachwirkend, belastet, innenliegend und drehrichtungsunabhängig mit Quenchkammer. Die Quenchkammer wird atmosphärenseitig mit einem Wellendichtring abgedichtet und dient zur Verhinderung von Ablagerungen und/oder zur Senkung der Temperatur im Gleitringdichtungsbereich.

Kombination der Gleitwerkstoffe in Siliziumkarbid (SiC). Balgwerkstoffe und Nebendichtungen aus EPDM und FPM. Metallische Teile aus Edelstahl oder Hastelloy C-4.

Geeignet für: Einsatz bei aggressiven Medien, die zum Auskristallisieren neigen.

Aufgabe der Quenchung:

- Verhinderung von Kristallisationsringen (Luftabschluss)
- Aufnahme der Leckage
- Kühlung der Gleitrings
- Überwachung der Leckrate
- Schmierfilm-Stabilisierung bei Vakuumbetrieb

Typ B2D

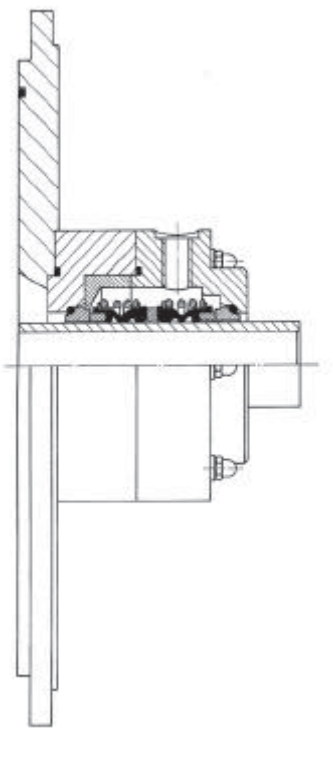

Doppeltwirkend, belastet, innenliegend und drehrichtungsunabhängig in «Back-to-back» - Anordnung mit Sperrkammer. Die «Back-to-back» - Anordnung ist die gebräuchlichste Form der Doppeldichtung für schwierige und chemisch besonders aggressive Medien.

Kombination der Gleitwerkstoffe in Siliziumkarbid (SiC). Balgwerkstoffe und Nebendichtungen aus EPDM und FPM. Metallische Teile aus Edelstahl.

Geeignet für Einsatz bei aggressiven und abrasiven Medien.

Aufgabe der Sperrung:

- Verhindern von Kontakt zwischen Förderflüssigkeit und Atmosphäre
- Schmierfilmbildung zwischen den Gleitringen
- Kühlung der Gleitringe
- Überwachung der Leckrate

Der kompetente Partner für Ihre Förderaufgaben...

ZIER Pumpen und Anlagen AG

9323 Steinach

Tel. 071 446 00 00 Fax 071 446 00 05
info@zier-anlagenbau.ch



Chemie-Normpumpe N

Kennlinien

In den Kennlinien-Blättern sind die Q-H-Kurven in Abhängigkeit des Schaufelrad-Durchmessers sowie der Leistungsbedarf in kW, der Wirkungsgrad und der NPSH-Wert (nur bei Nenndrehzahl 2900 min⁻¹) aufgezeigt. Förderwert- und Wirkungsgradgarantien gemäß DIN 1944.

Typ N 50 - 32 - 125

Motor kW: 2,2
Drehzahl: 2900

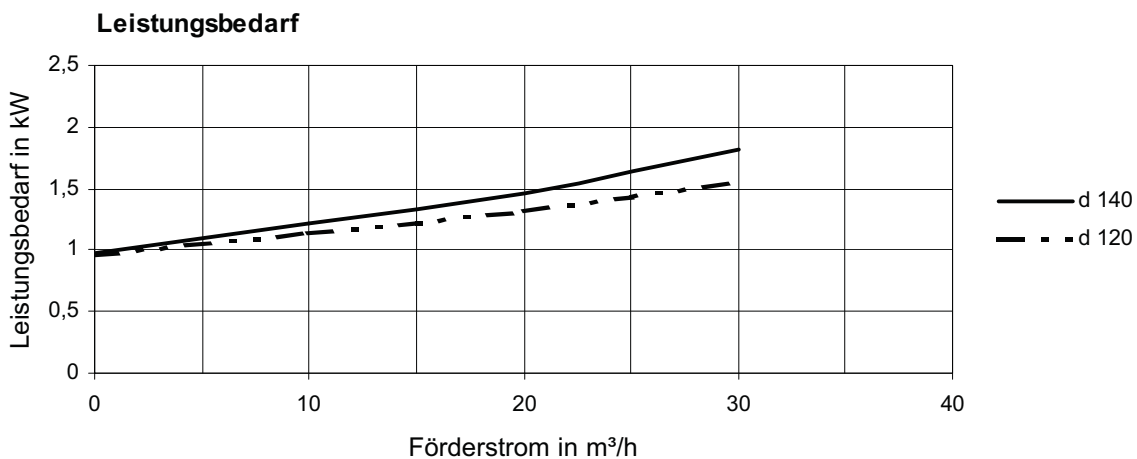
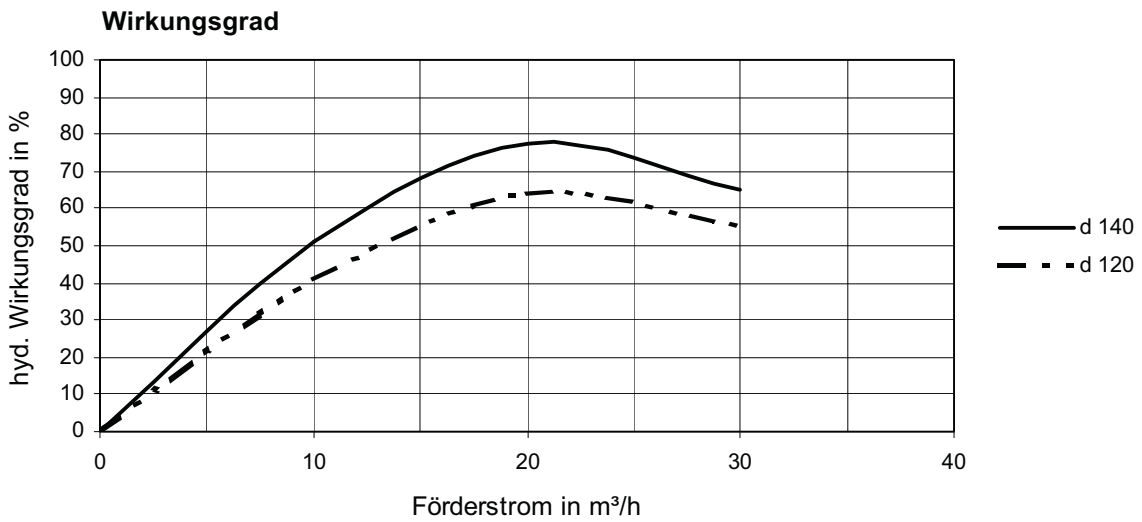
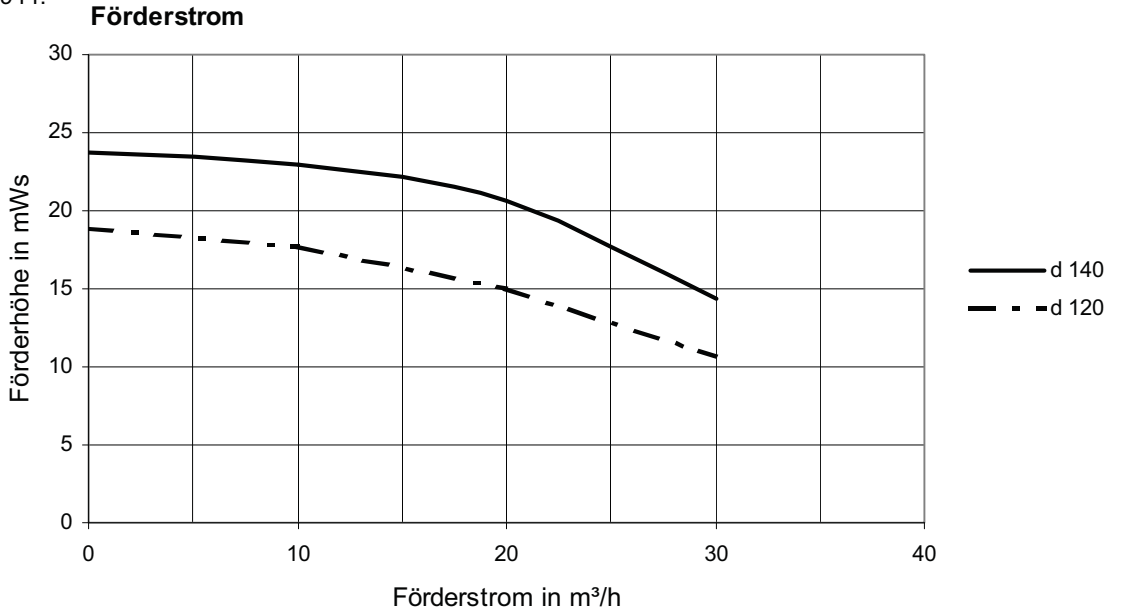

Chemie-Normpumpe N

Typ N 50 - 32 - 125

Motor kW: 1,1
Drehzahl: 1450

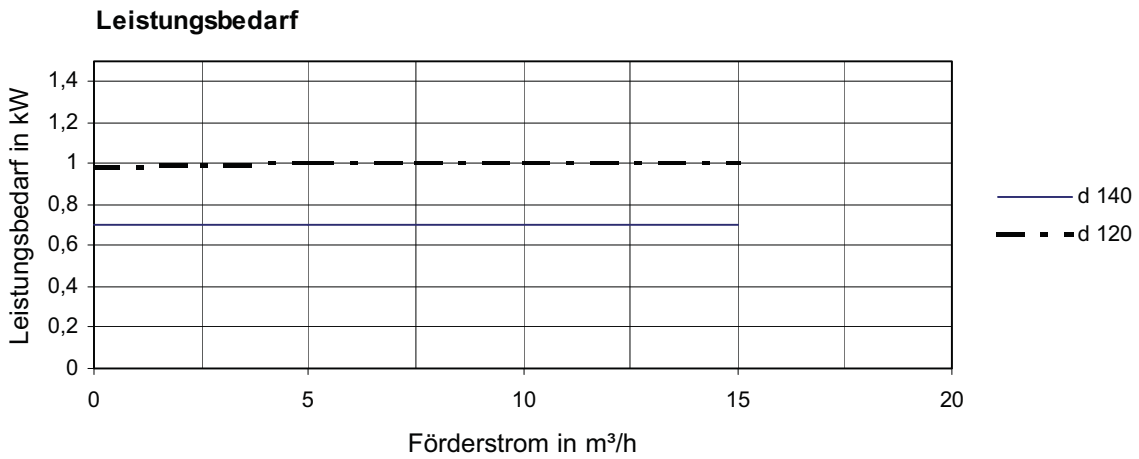
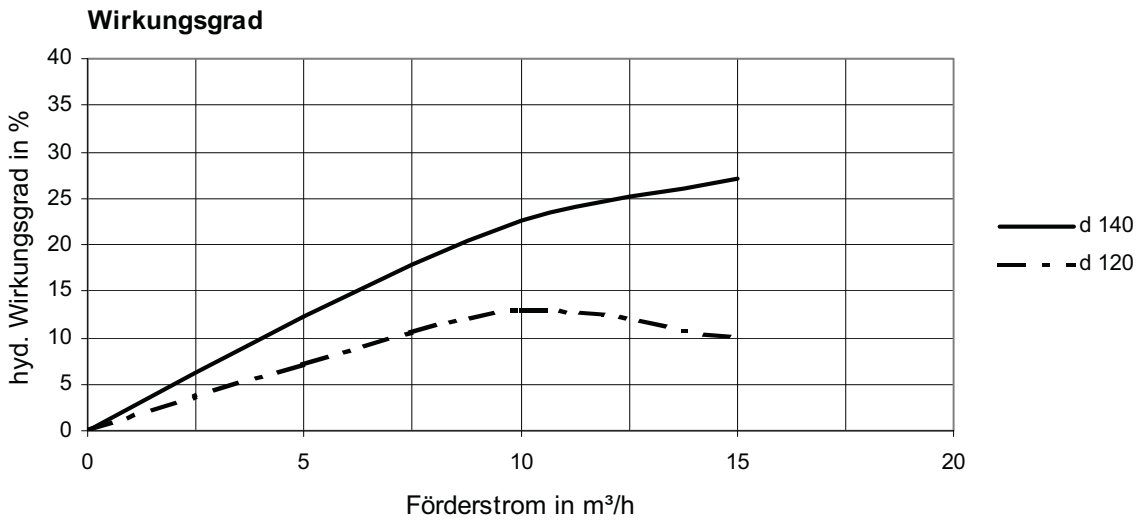
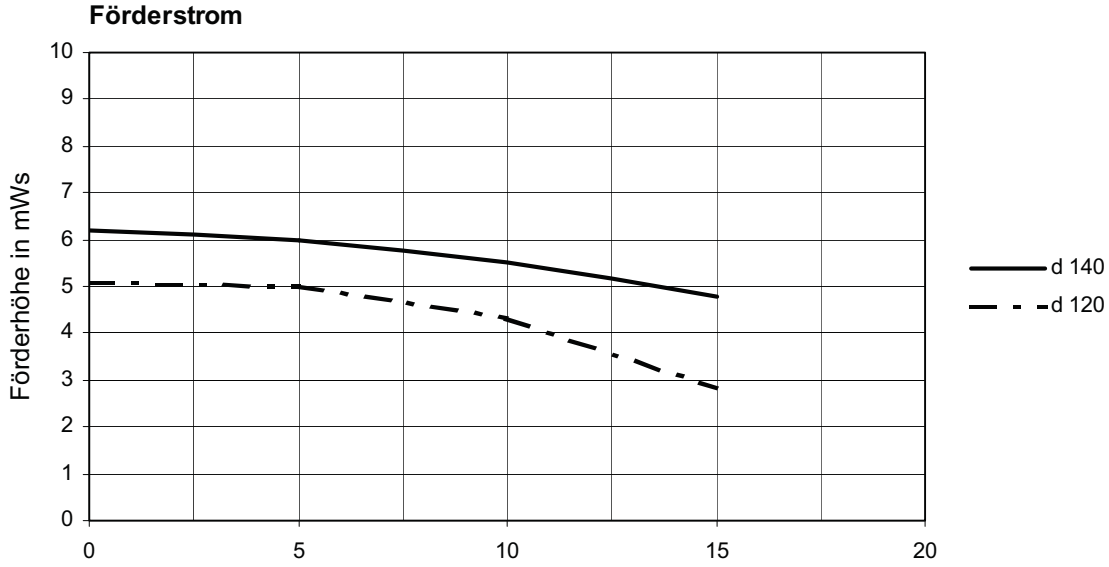

Typ N 50 - 32 - 160

Motor kW: 4
Drehzahl: 2900

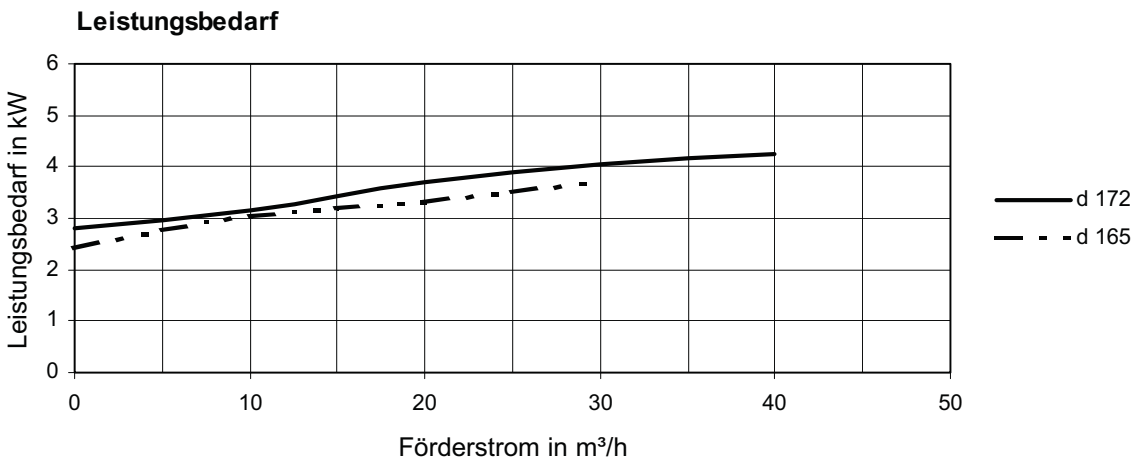
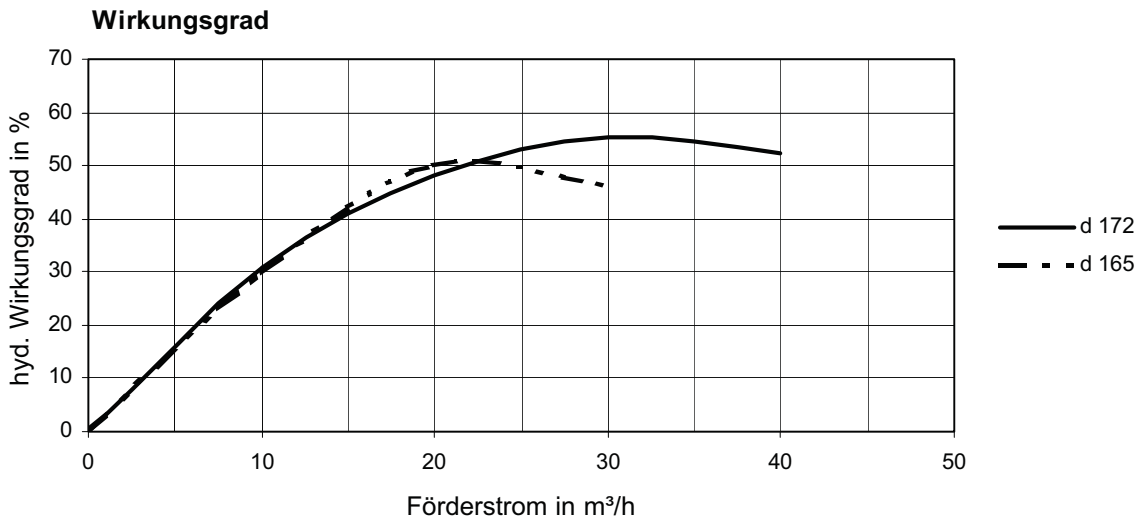
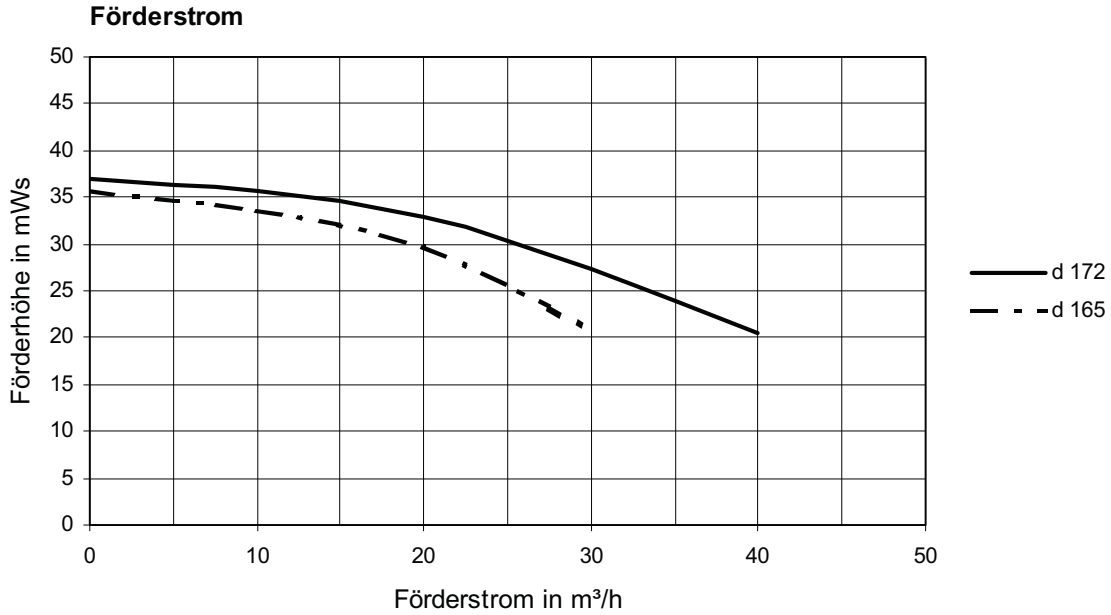

Chemie-Normpumpe N

Typ N 50 - 32 - 160

Motor kW: 1,5
Drehzahl: 1450

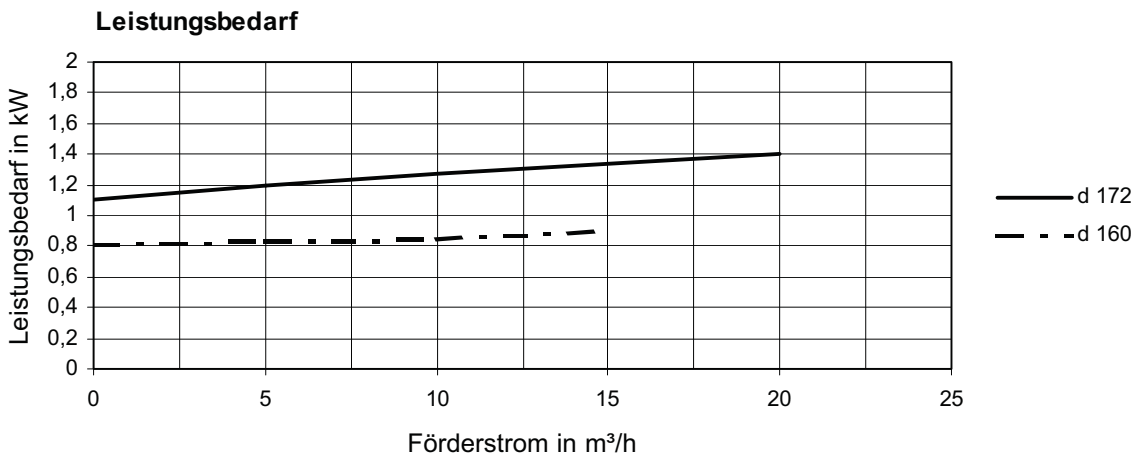
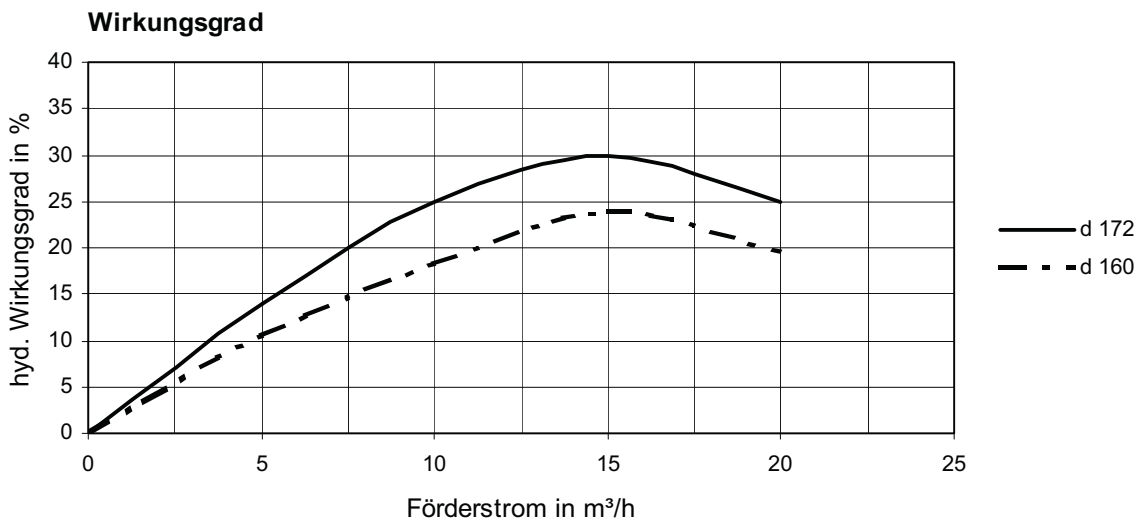
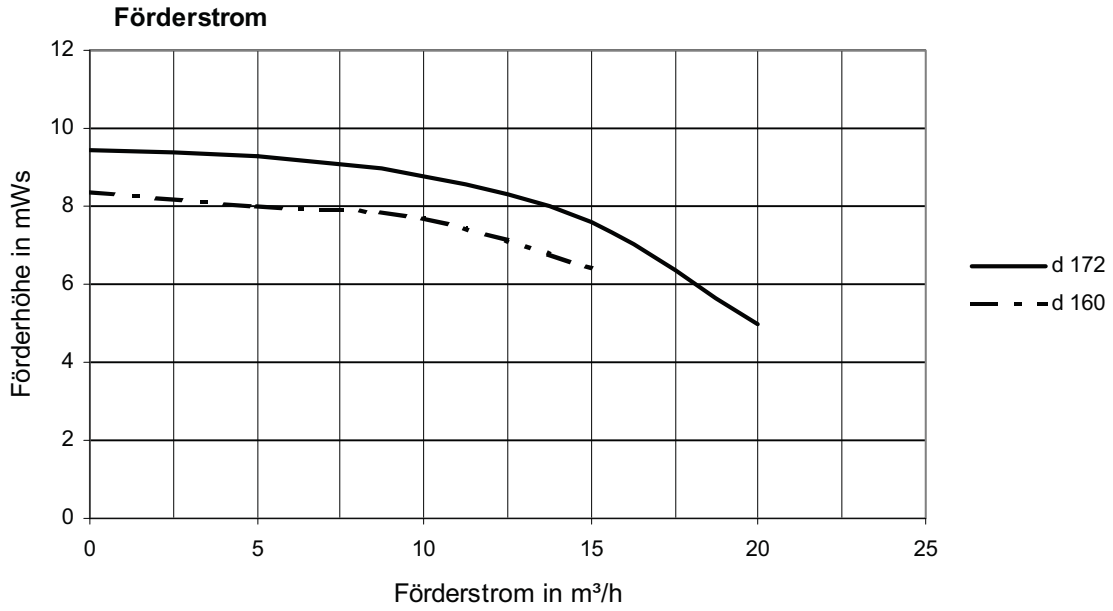

Chemie-Normpumpe N

Typ N 50 - 32 - 200

Motor kW: 7,5
Drehzahl: 2900

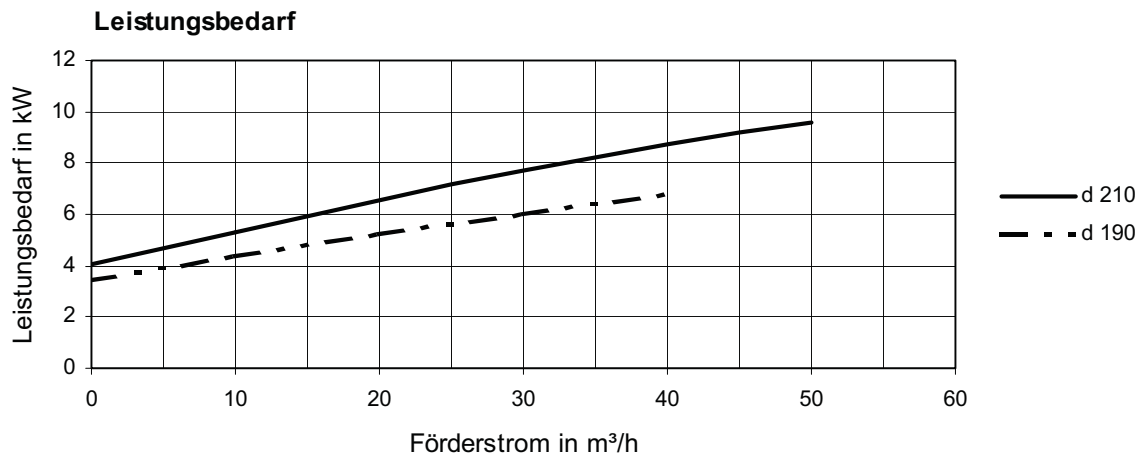
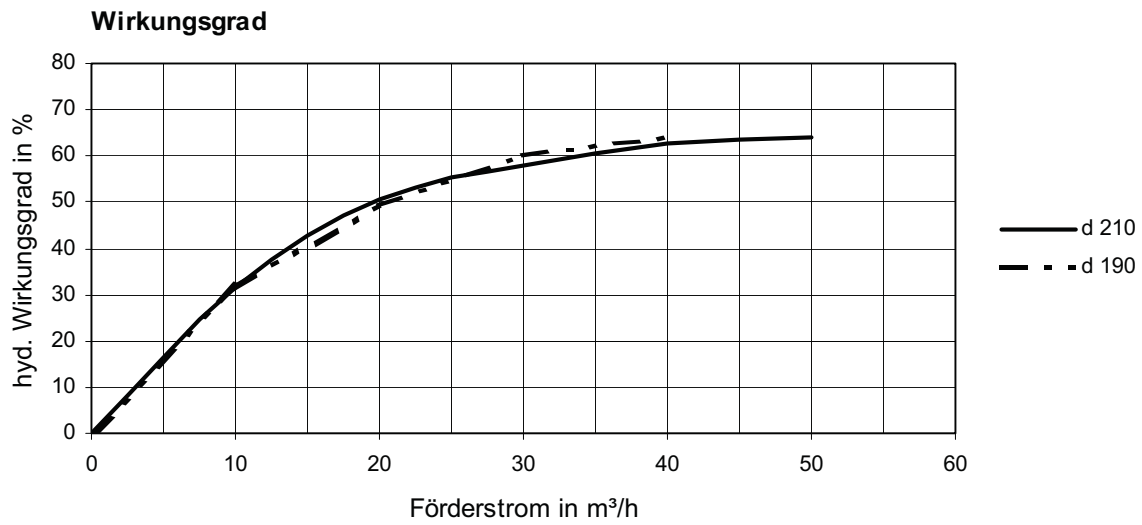
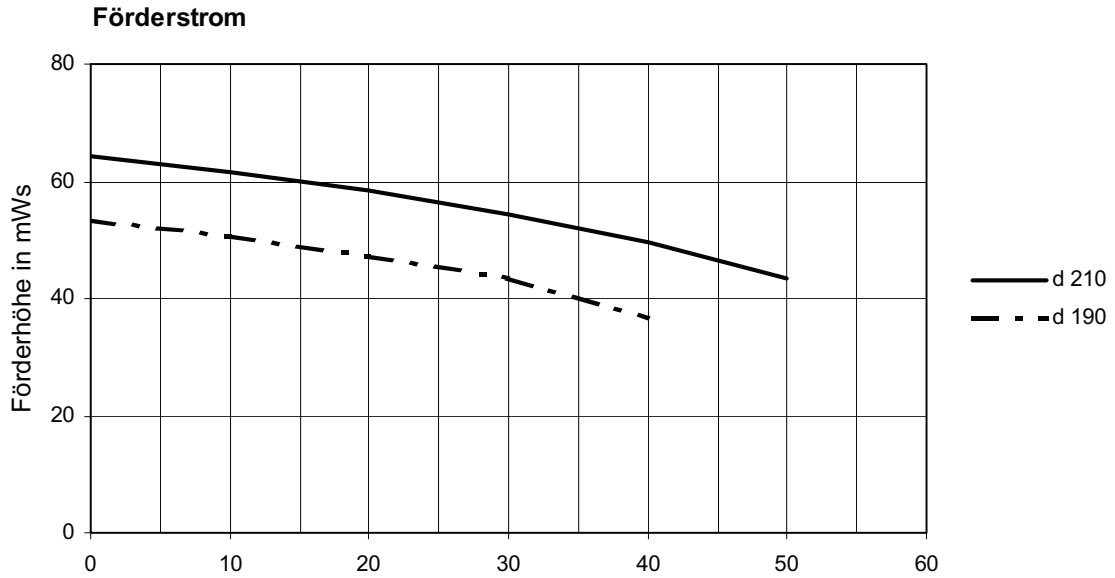

Chemie-Normpumpe N

Typ N 50 - 32 - 200

Motor kW: 1,5
Drehzahl: 1450

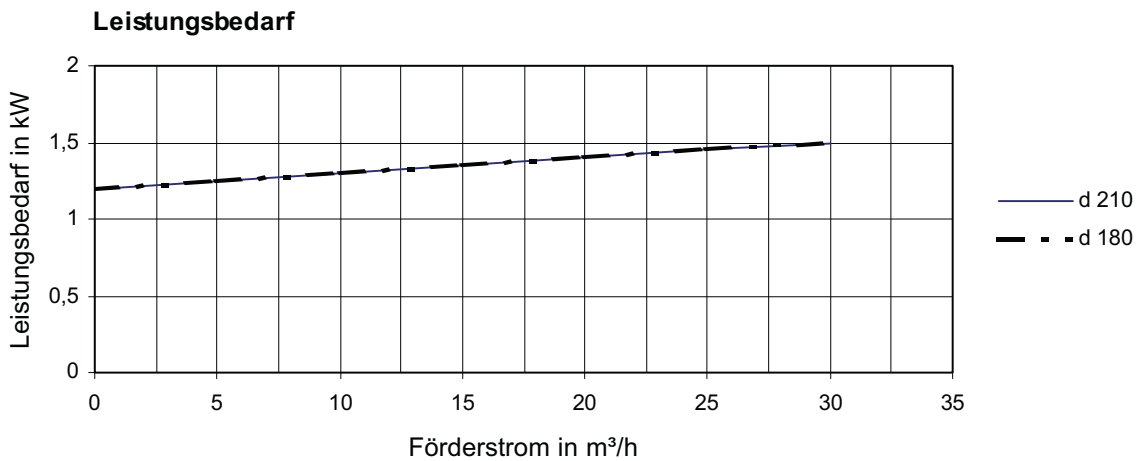
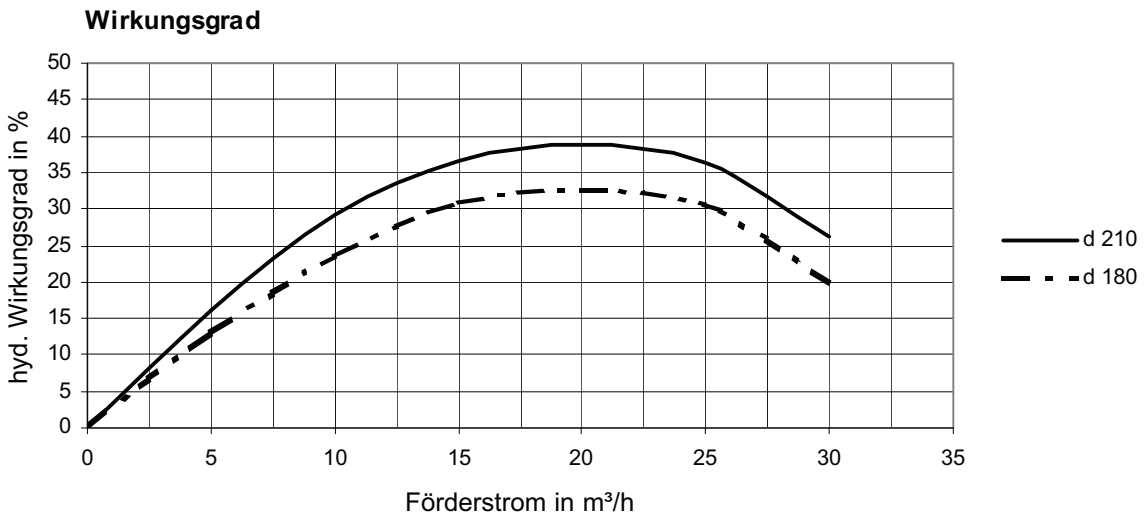
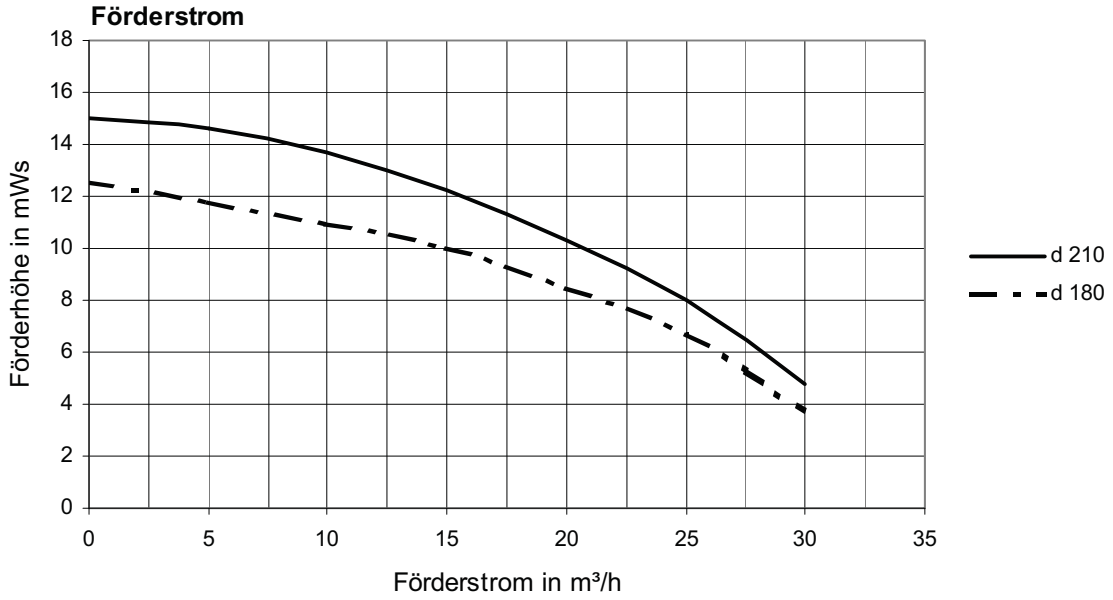

Chemie-Normpumpe N

Typ N 50 - 32 - 250

Motor kW: 3
Drehzahl: 2900

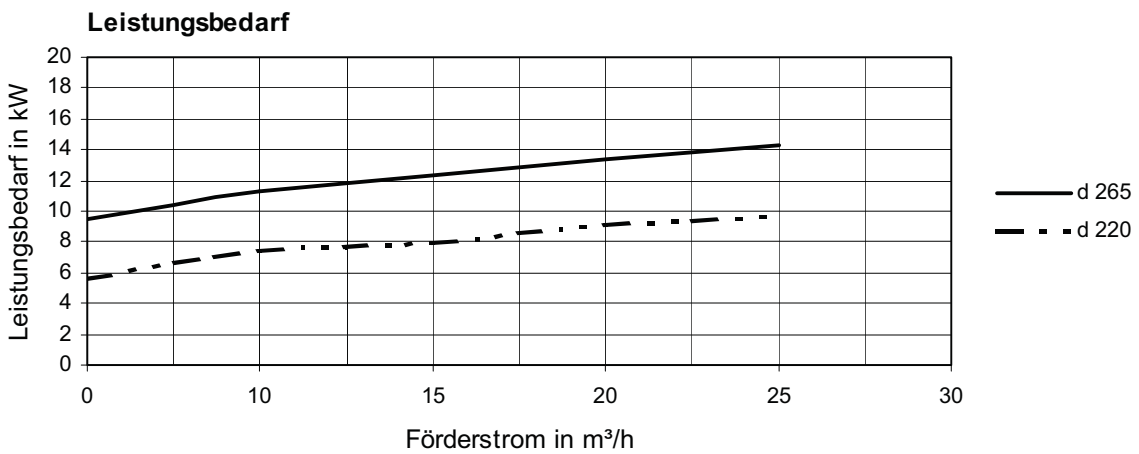
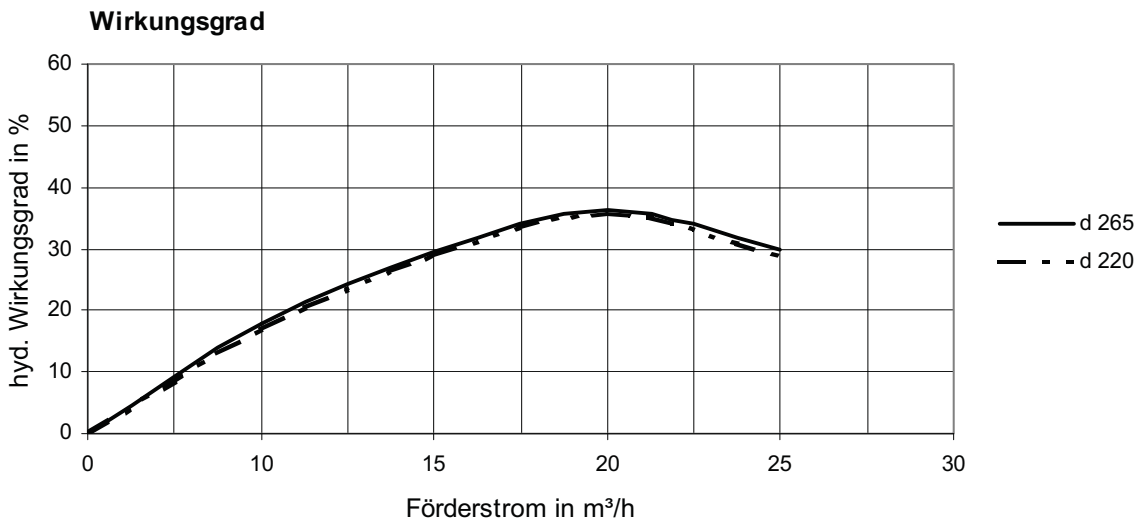
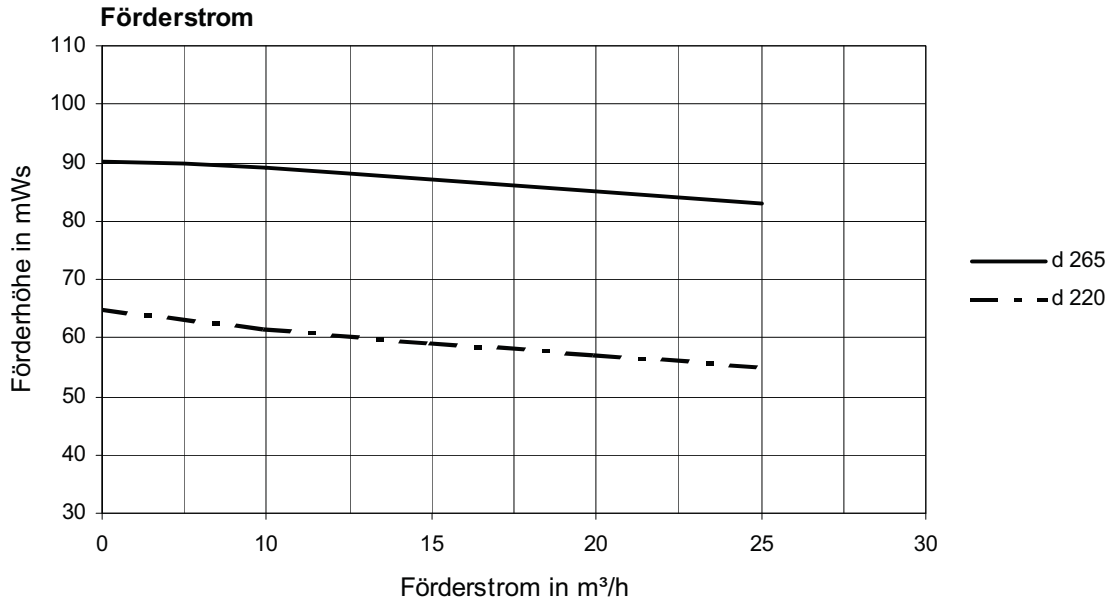

Chemie-Normpumpe N

Typ N 50 - 32 - 250

Motor kW: 2,2
Drehzahl: 1450

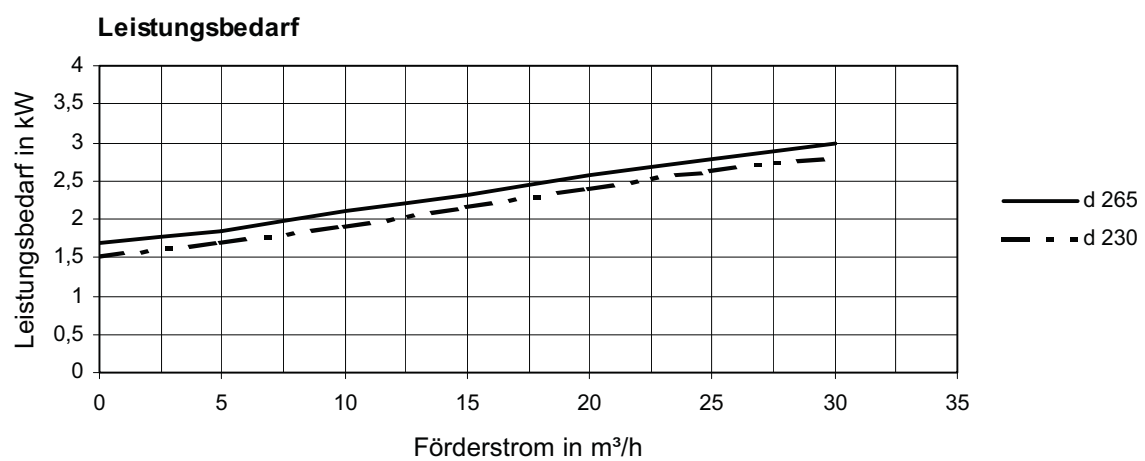
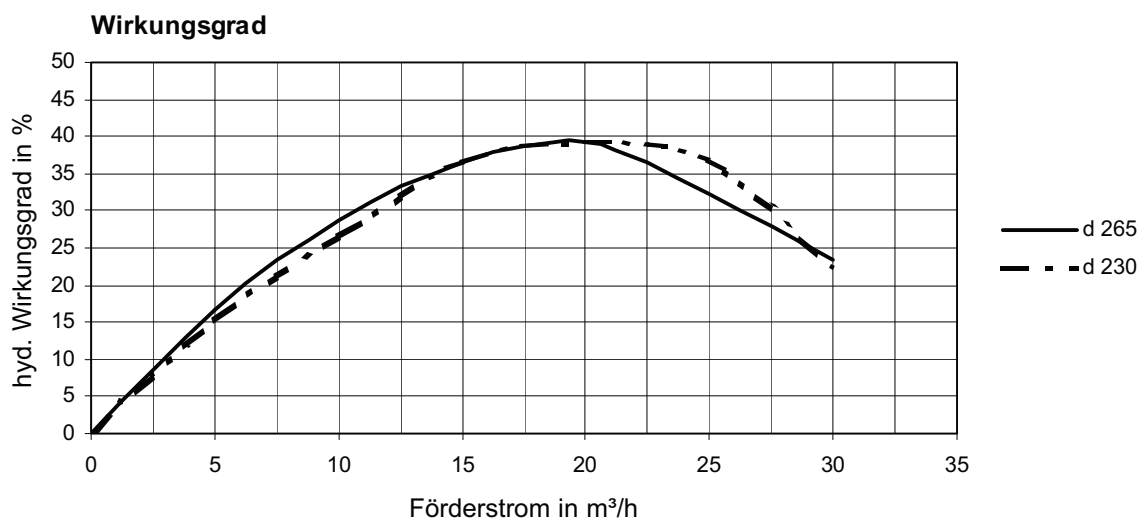
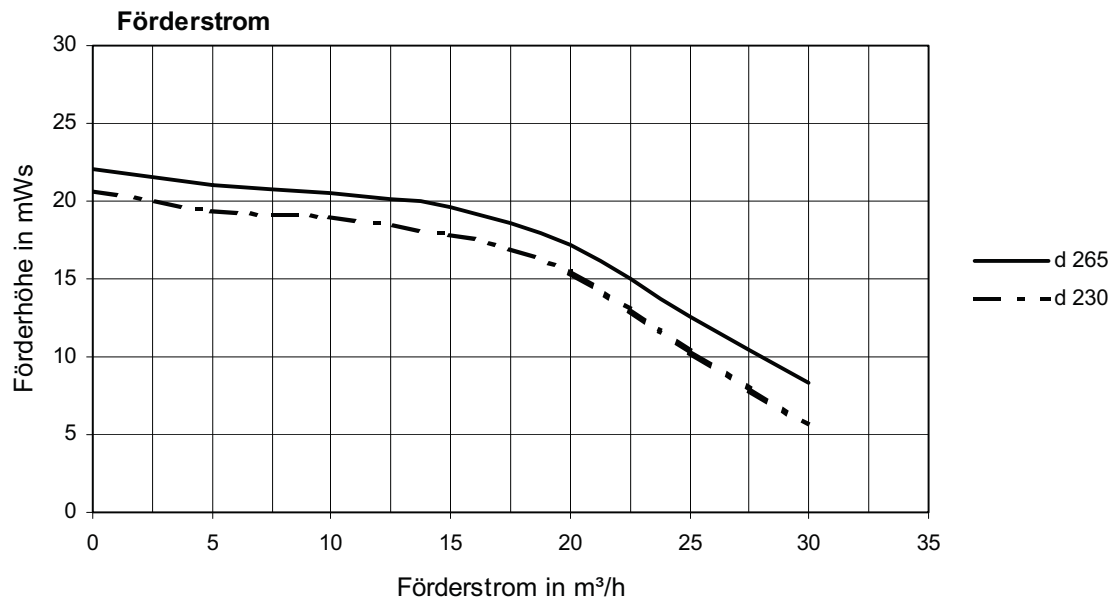

Chemie-Normpumpe N

Typ N 65 - 40 - 125

Motor kW: 3
Drehzahl: 2900

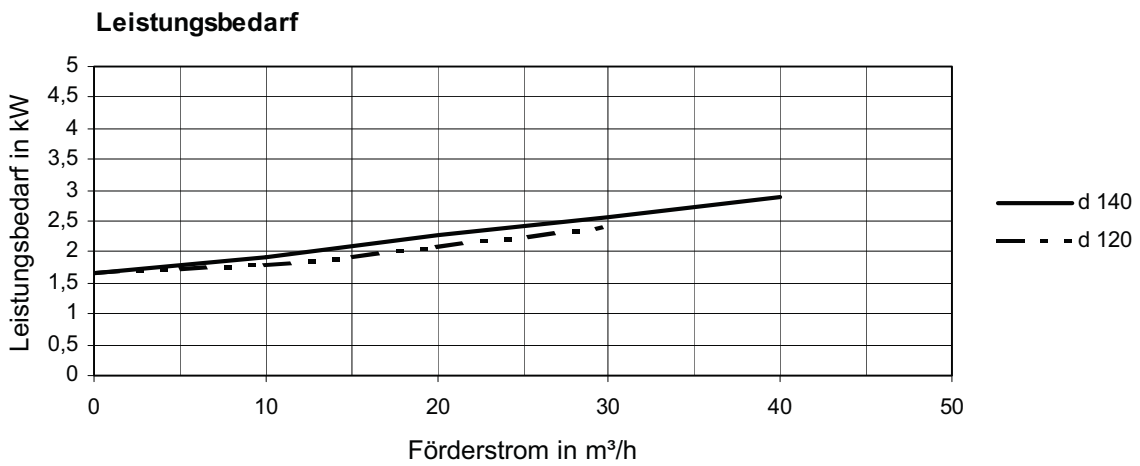
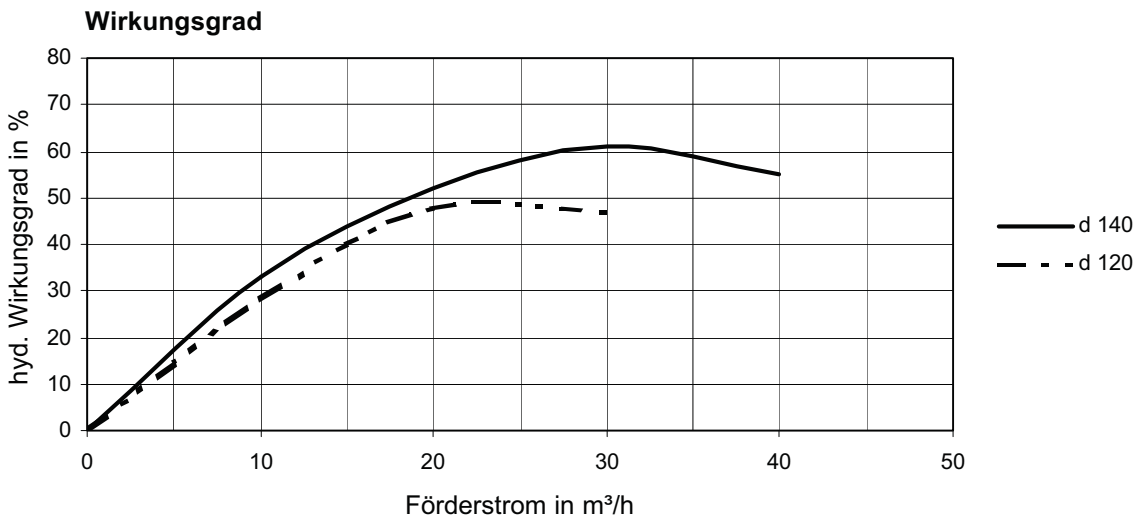
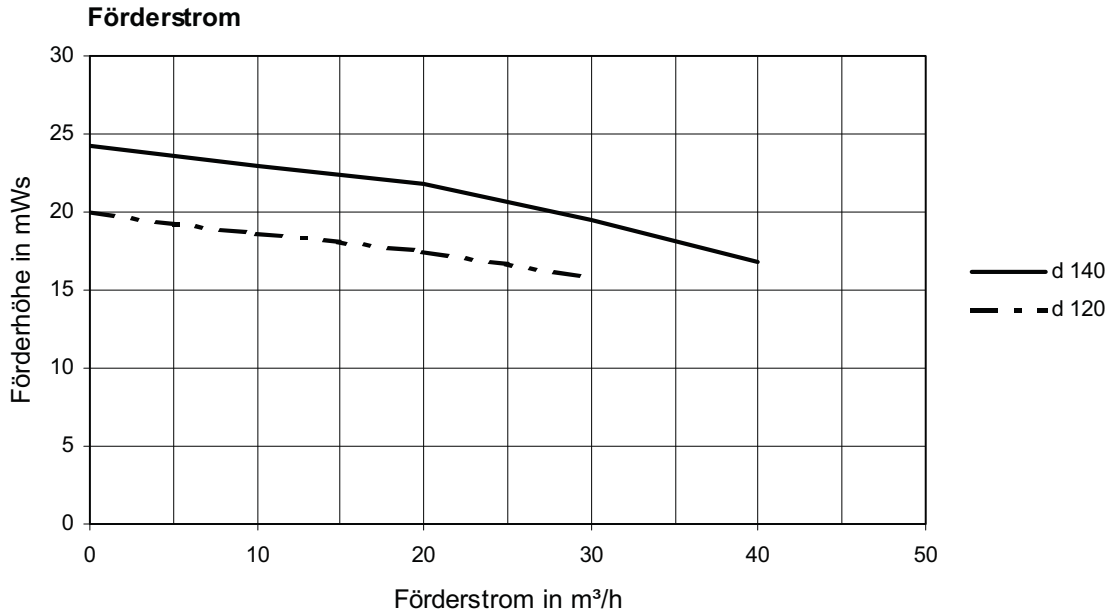

Chemie-Normpumpe N

Typ N 65 - 40 - 125

Motor kW: 1,5
Drehzahl: 1450

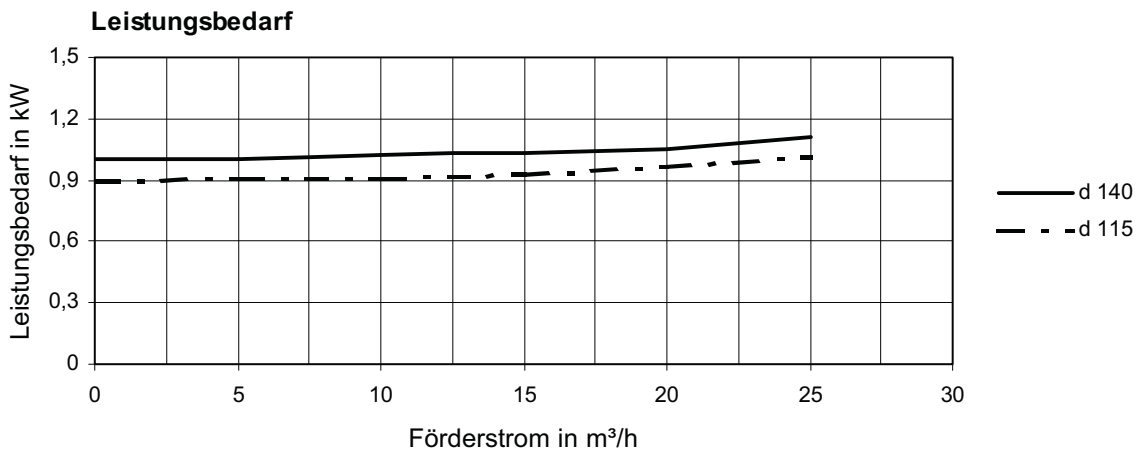
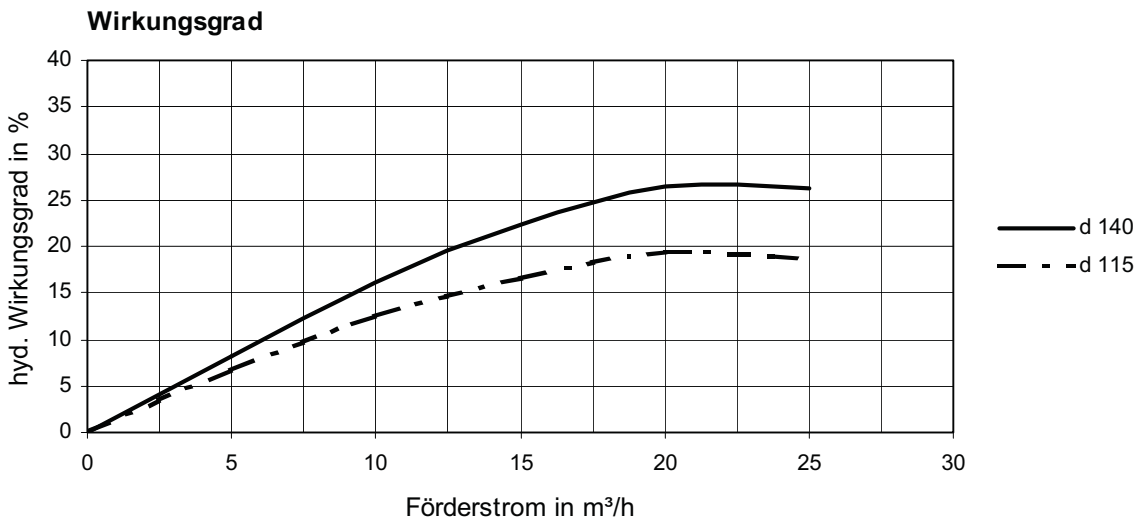
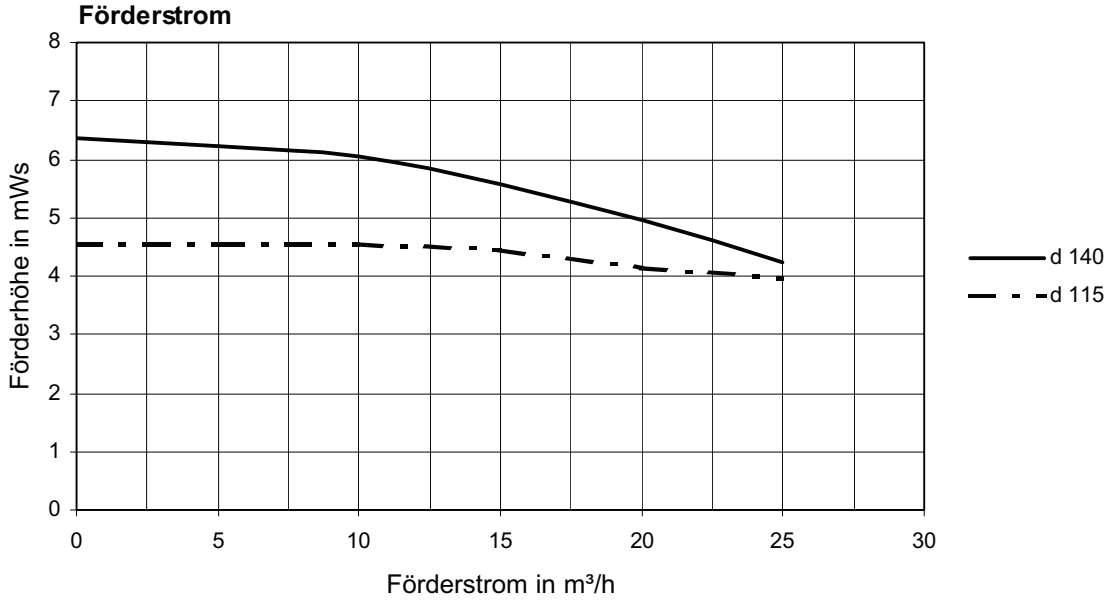

Typ N 65 - 40 - 160

Motor kW: 7,5
Drehzahl: 2900

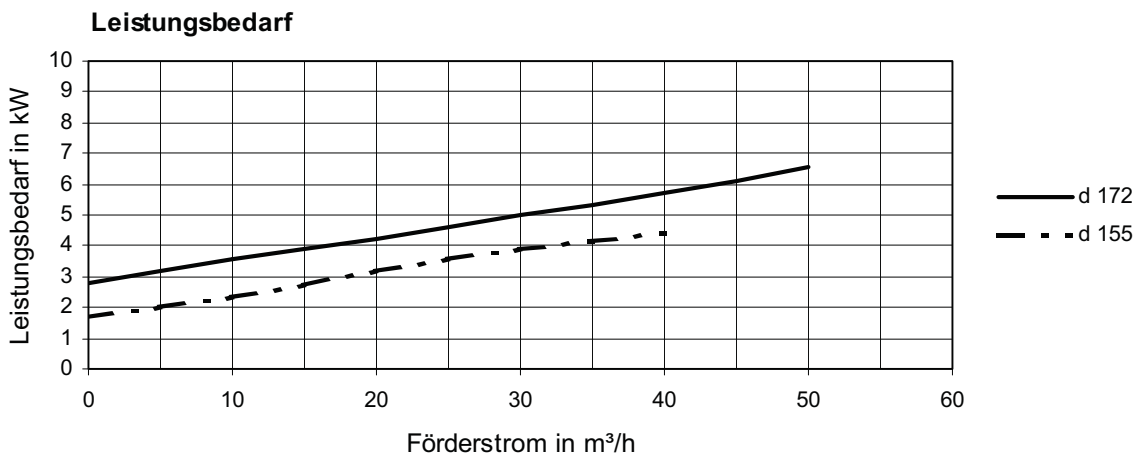
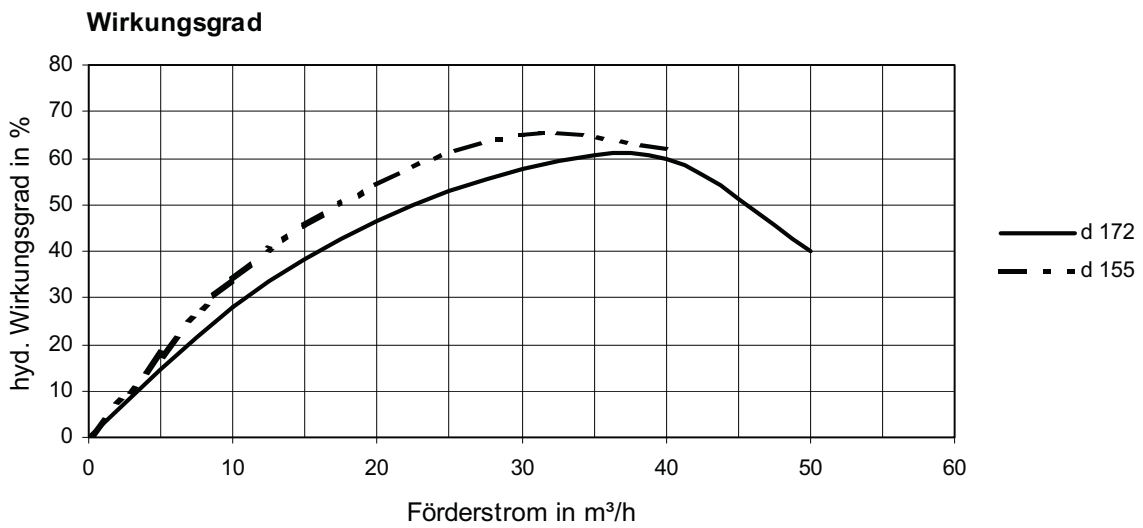
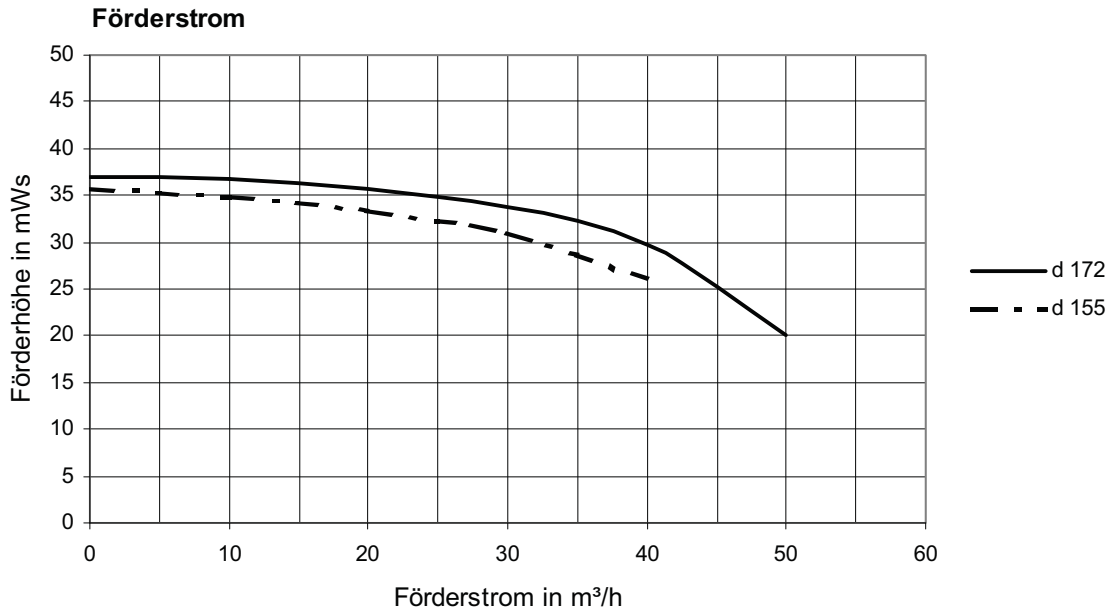

Typ N 65 - 40 - 160

Motor kW: 2,2
Drehzahl: 1450

Chemie-Normpumpe N

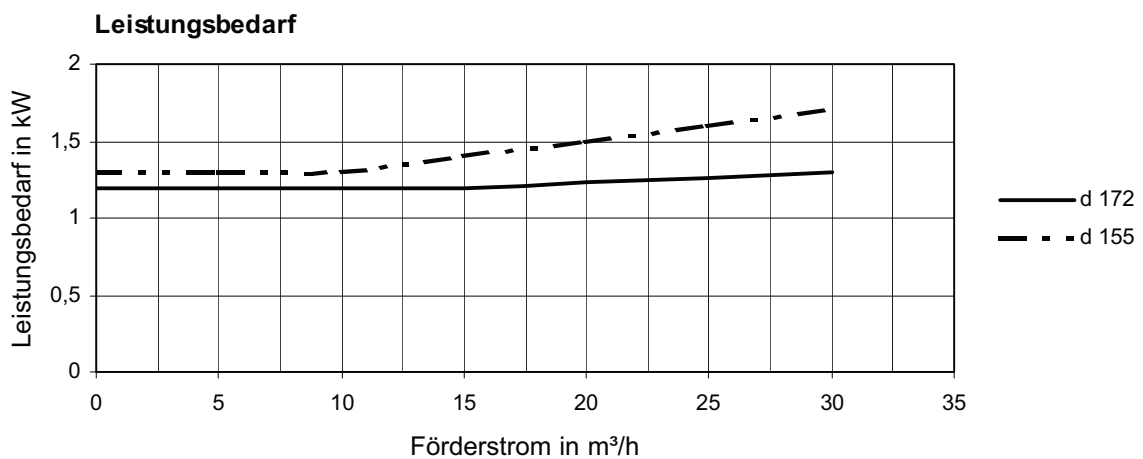
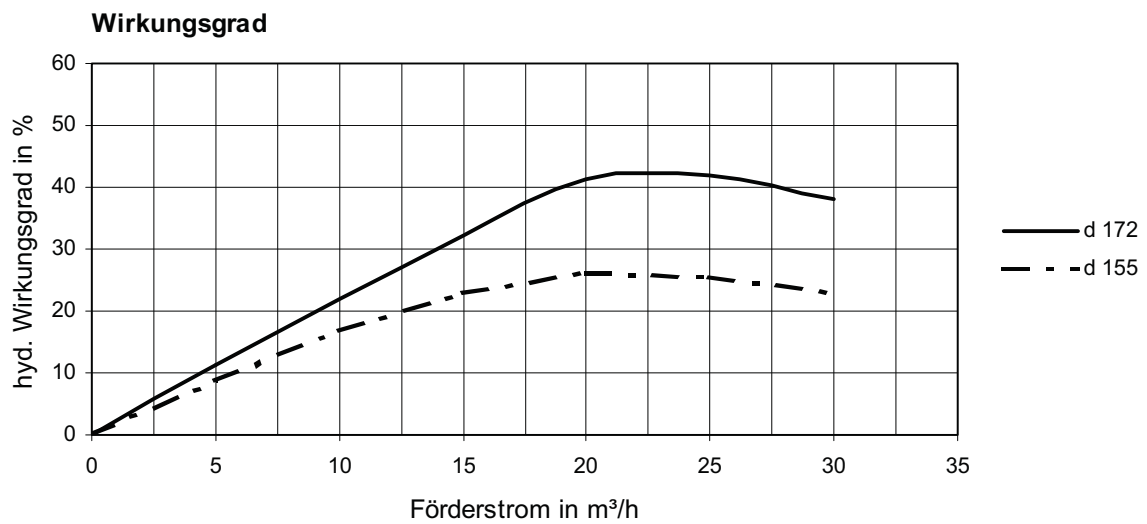
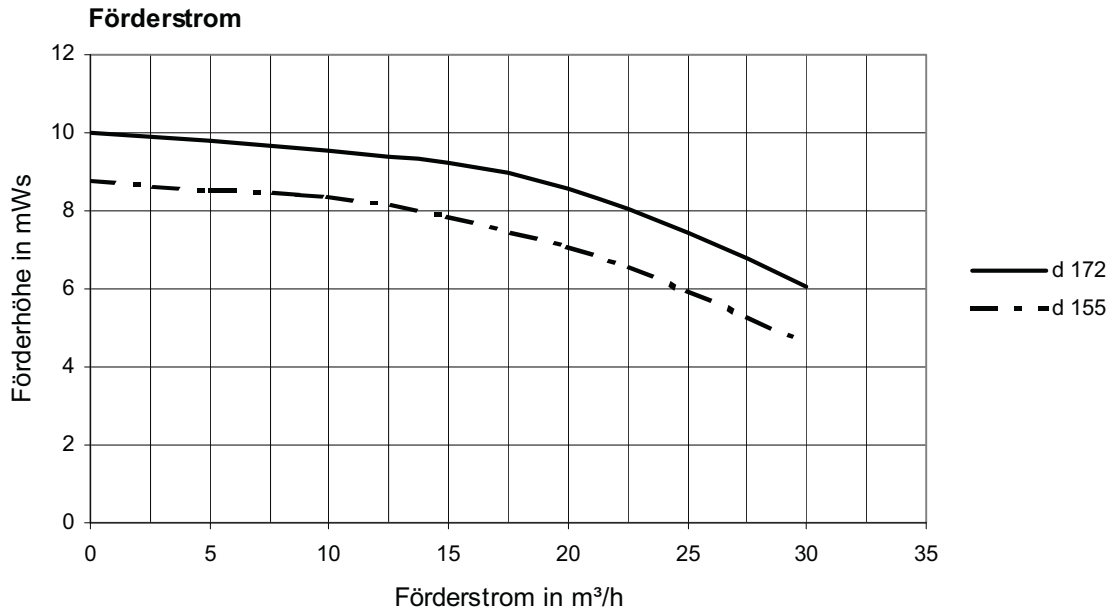

Chemie-Normpumpe N

Typ N 65 - 40 - 200

Motor kW: 7,5
Drehzahl: 2900

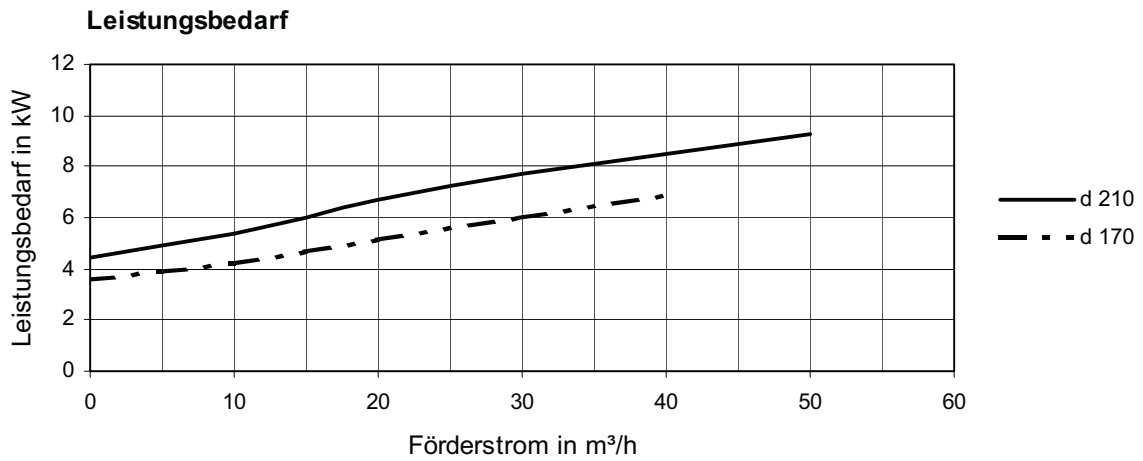
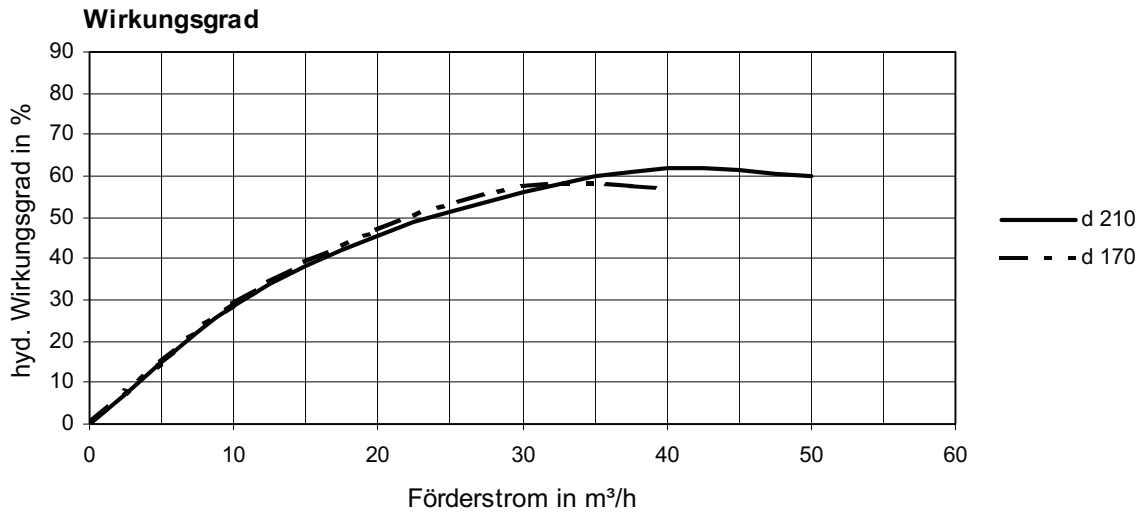
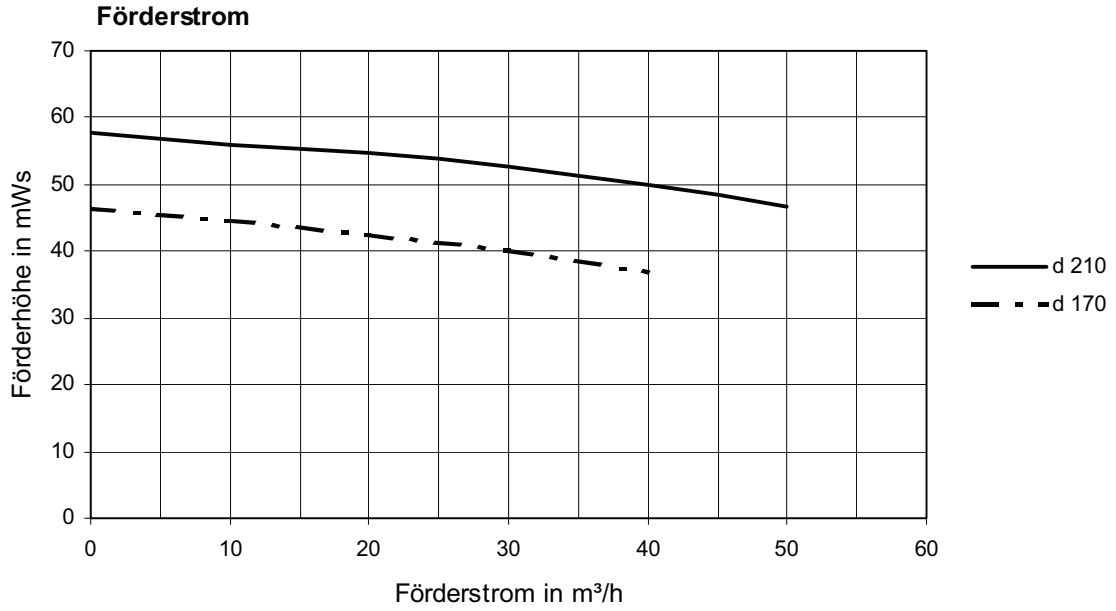

Chemie-Normpumpe N

Typ N 65 - 40 - 200

Motor kW: 2,5
Drehzahl: 1450

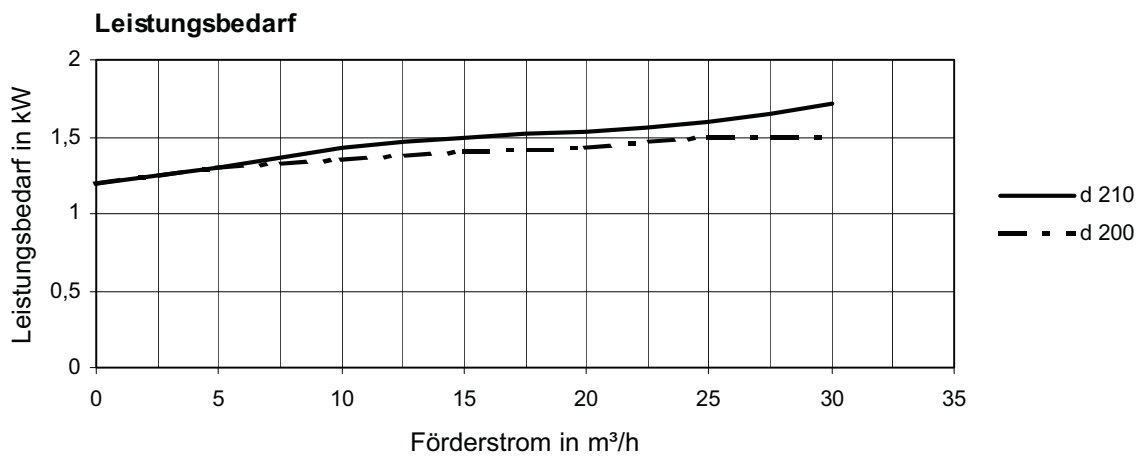
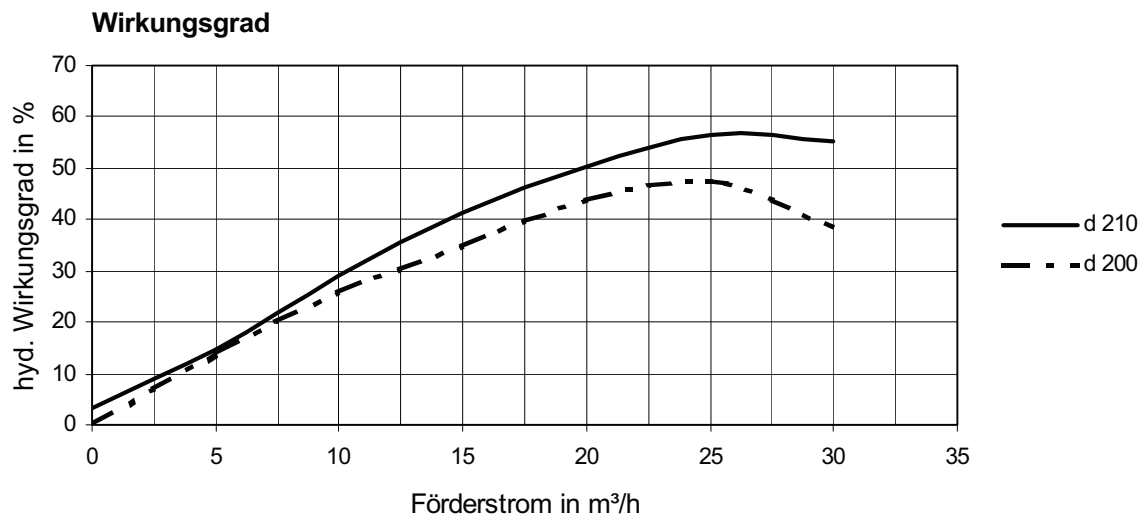
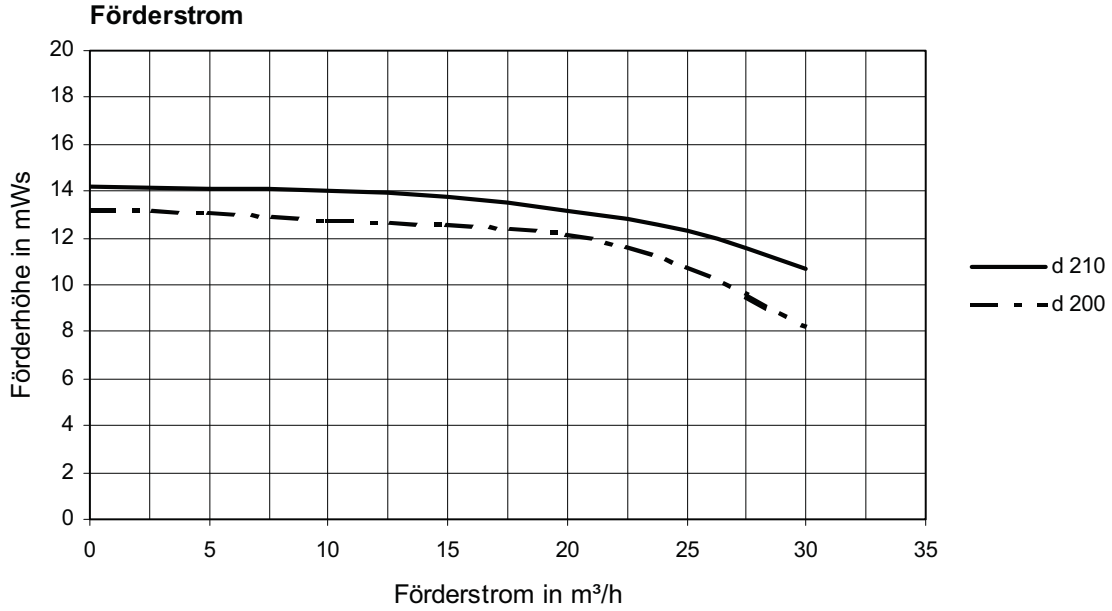

Chemie-Normpumpe N

Typ N 65 - 40 - 250

Motor kW: 22
Drehzahl: 2900

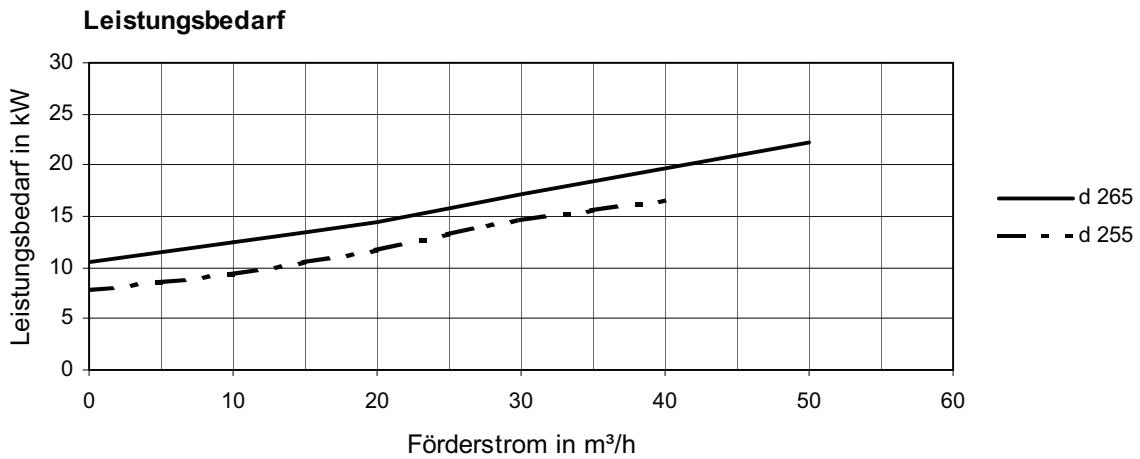
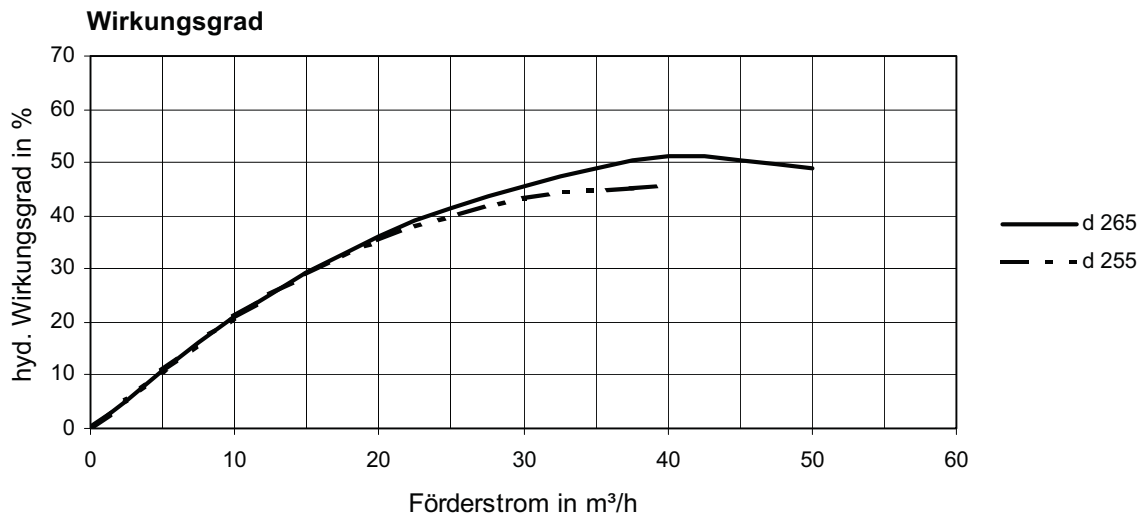
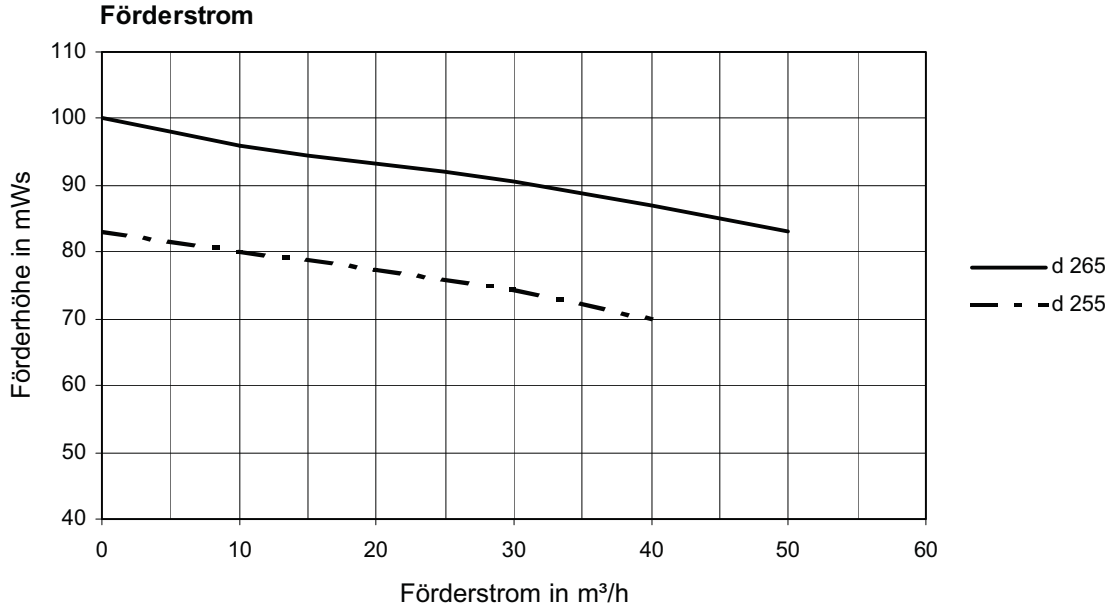

Typ N 65 - 40 - 250

Motor kW: 5,5
Drehzahl: 1450

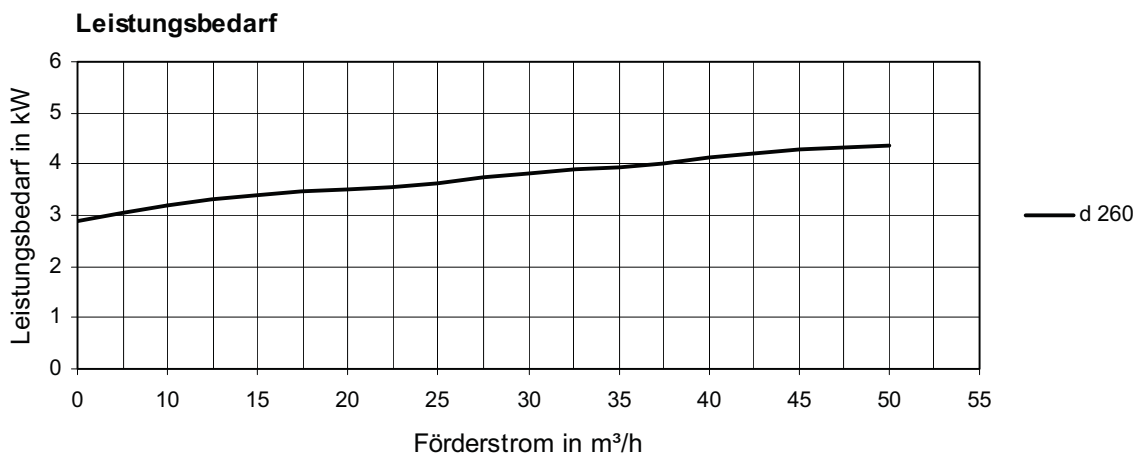
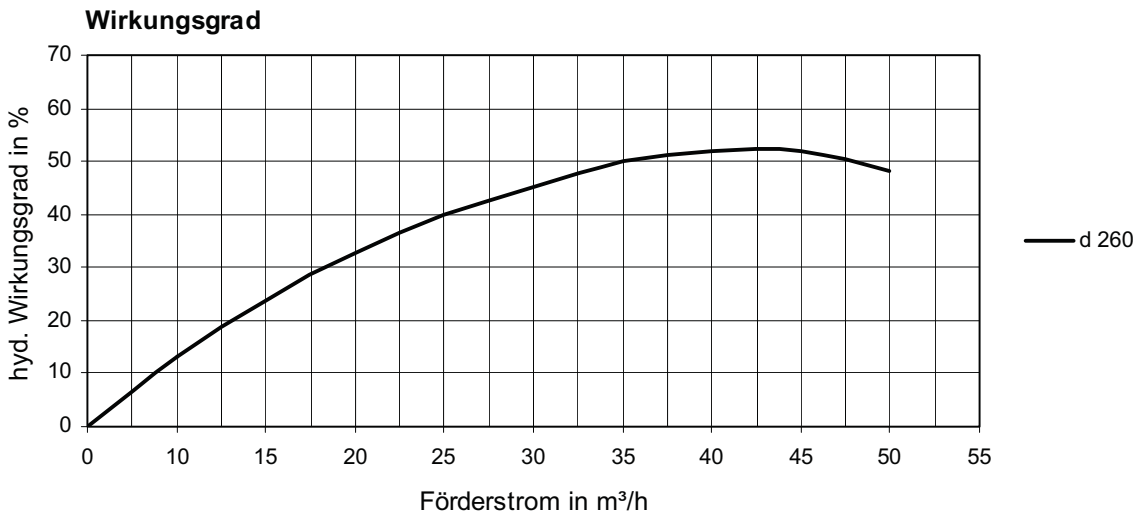
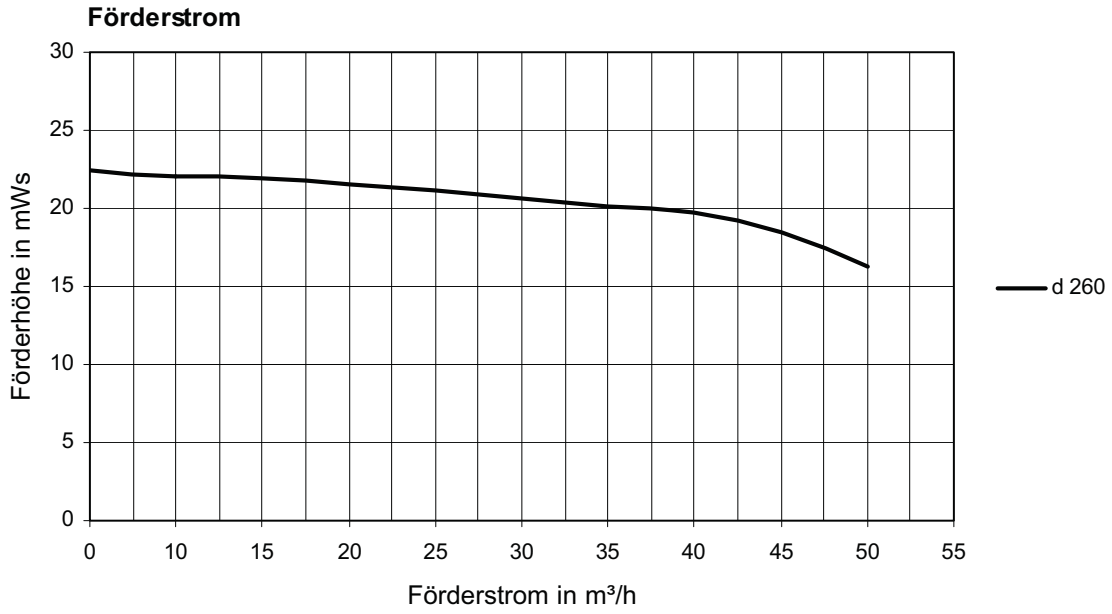

Typ N 65 - 40 - 315

Motor kW: 30
Drehzahl: 2900

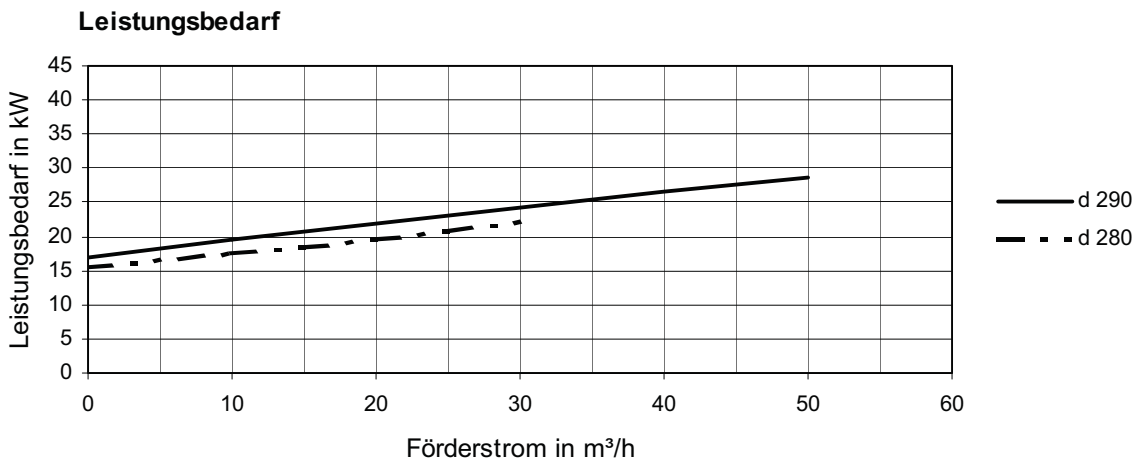
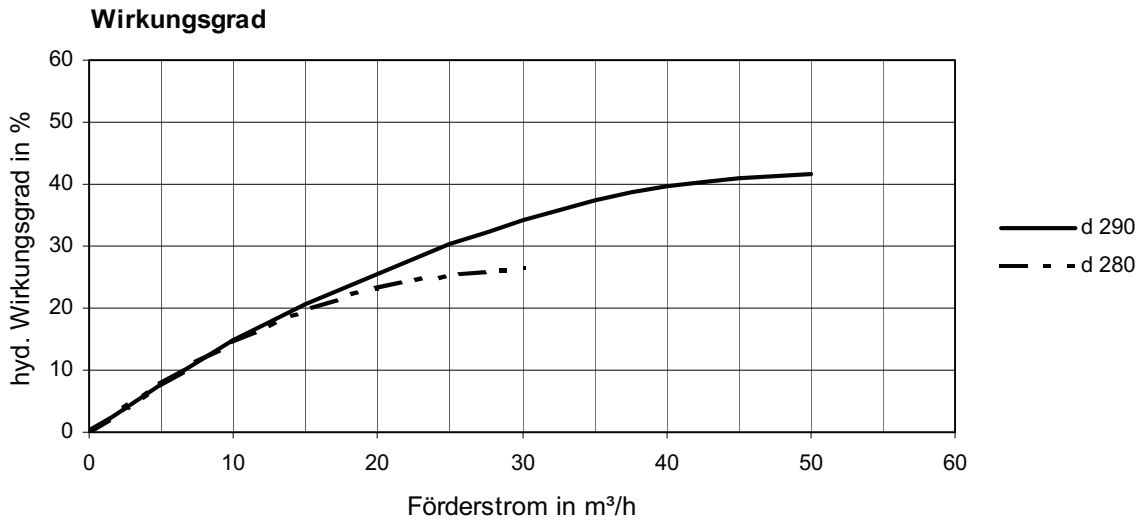
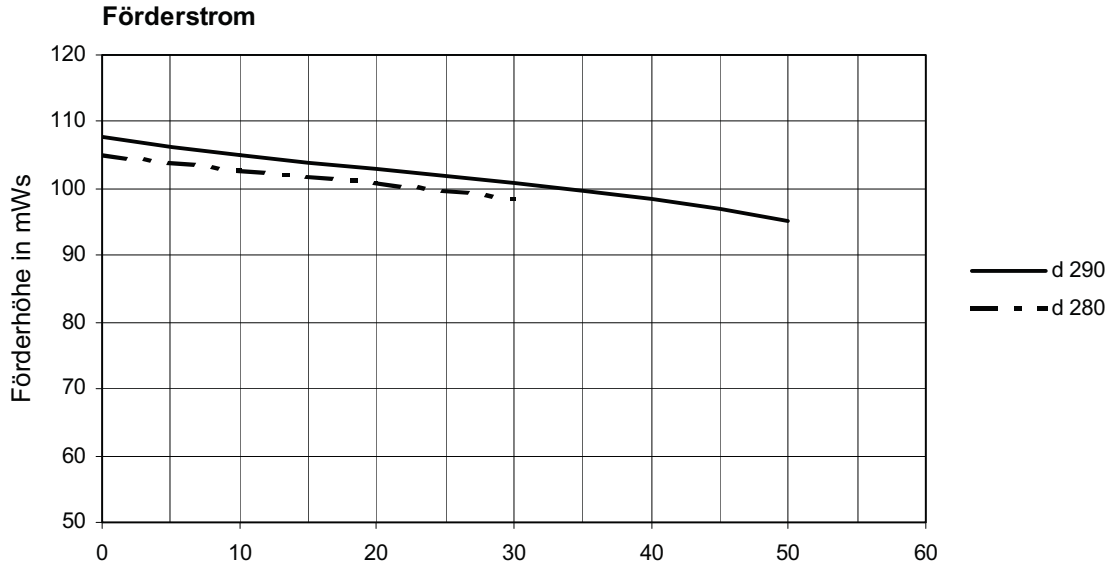

Typ N 65 - 40 - 315

Motor kW: 5,5
Drehzahl: 1450

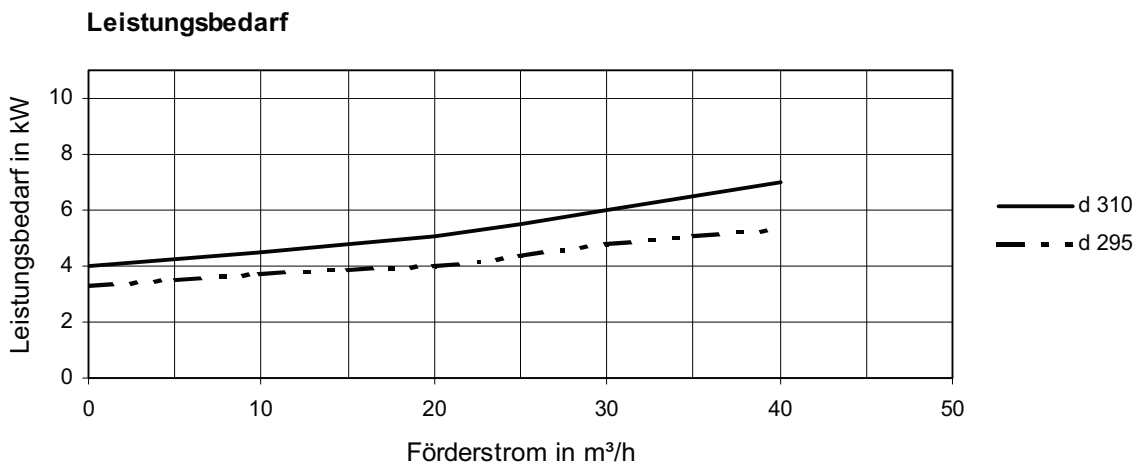
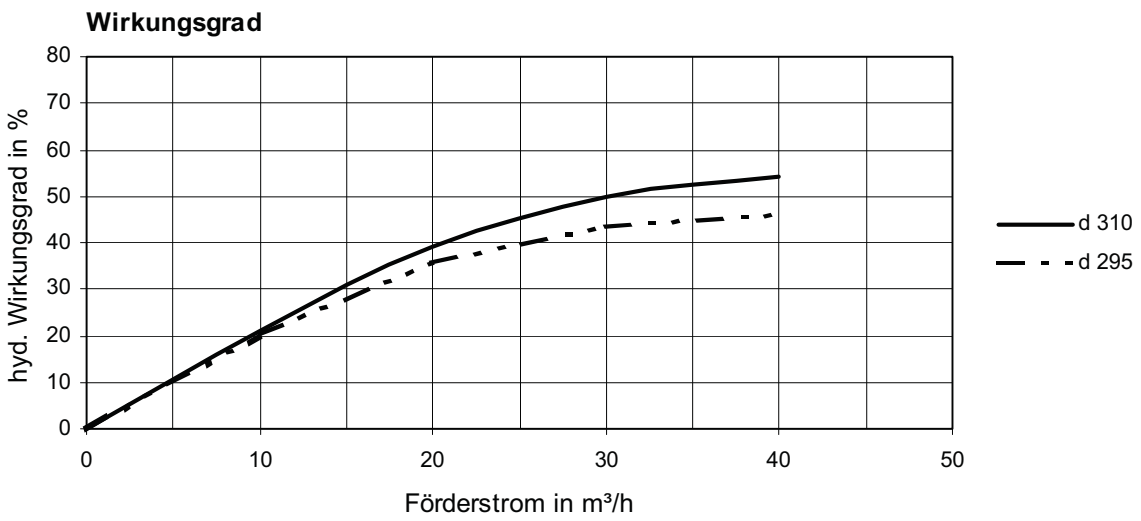
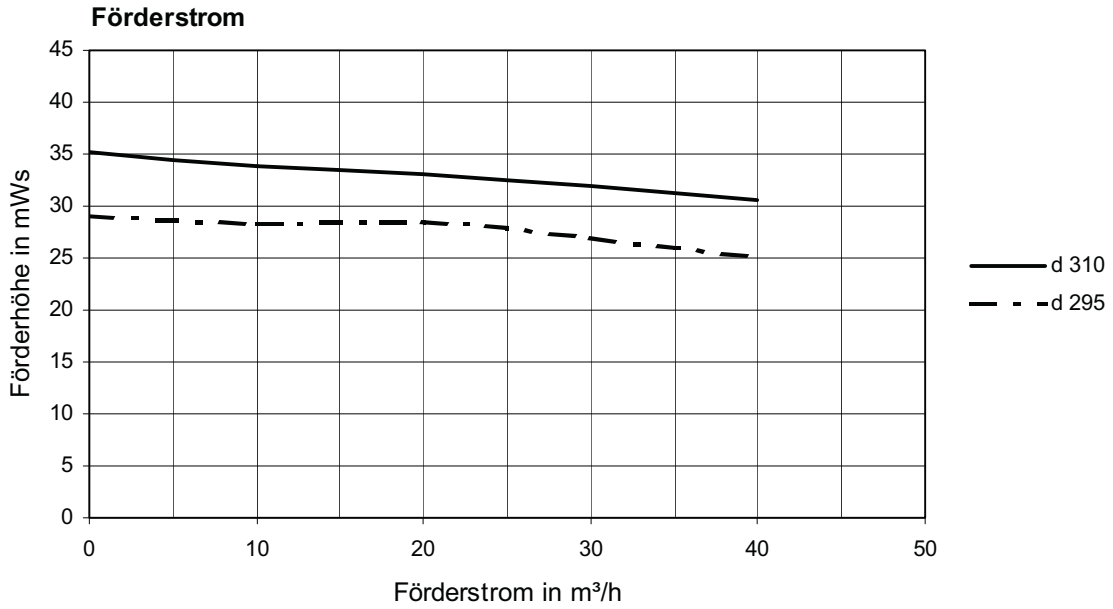

Typ N 80 - 50 - 125

Motor kW: 7,5
Drehzahl: 2900

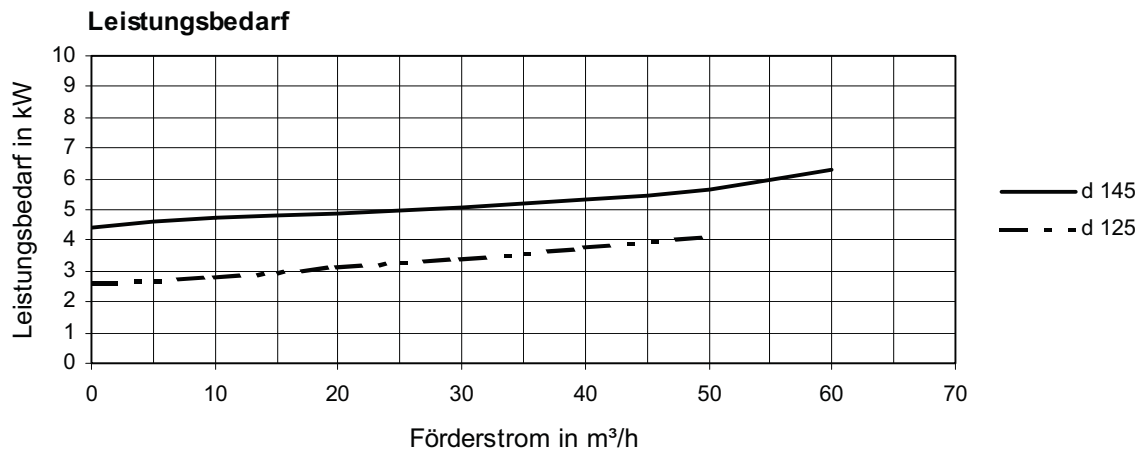
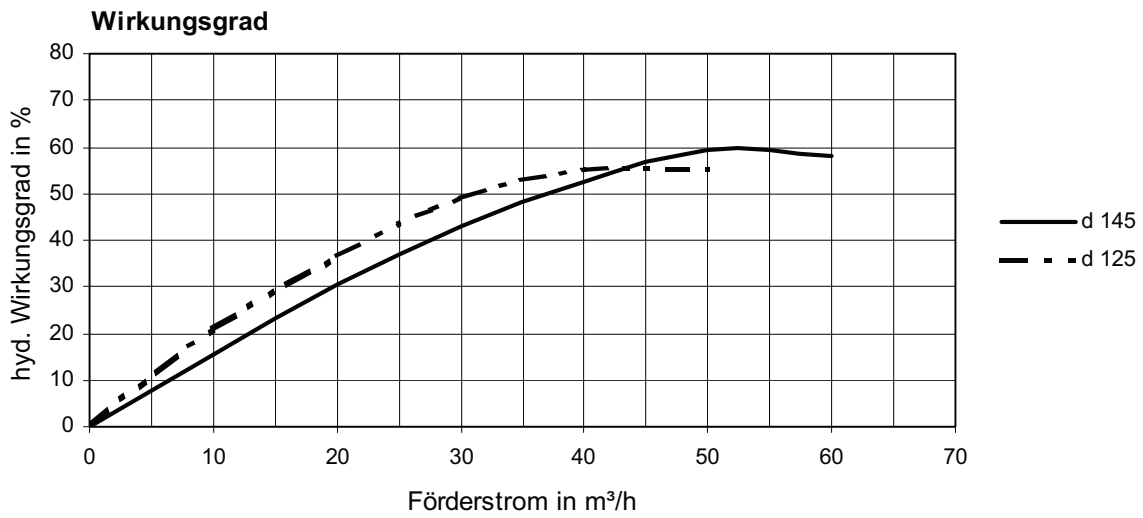
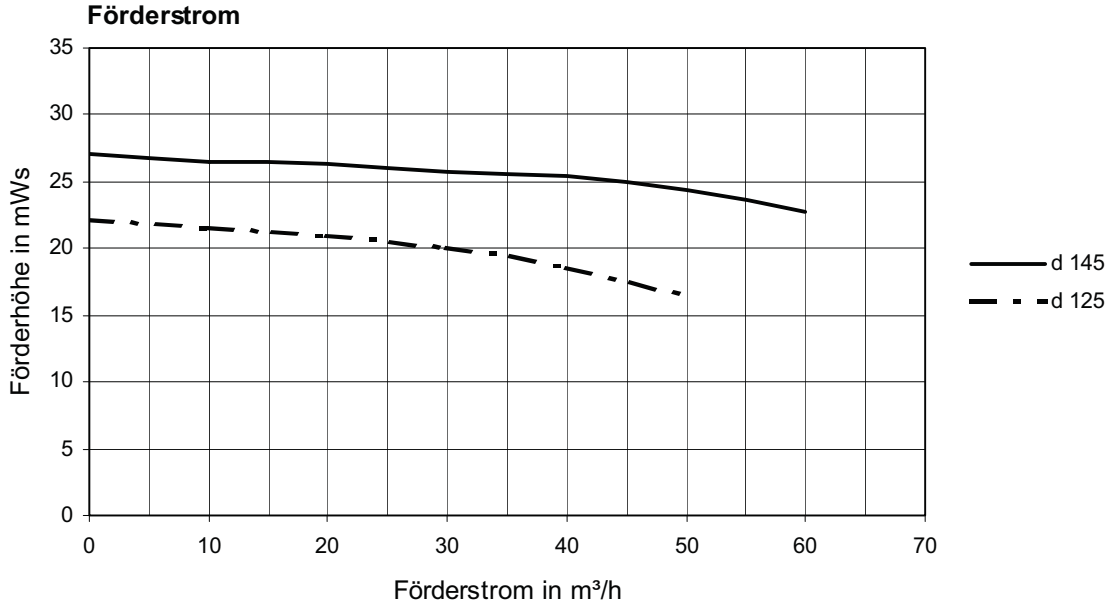

Typ N 80 - 50 - 125

Motor kW: 1,5
Drehzahl: 1450

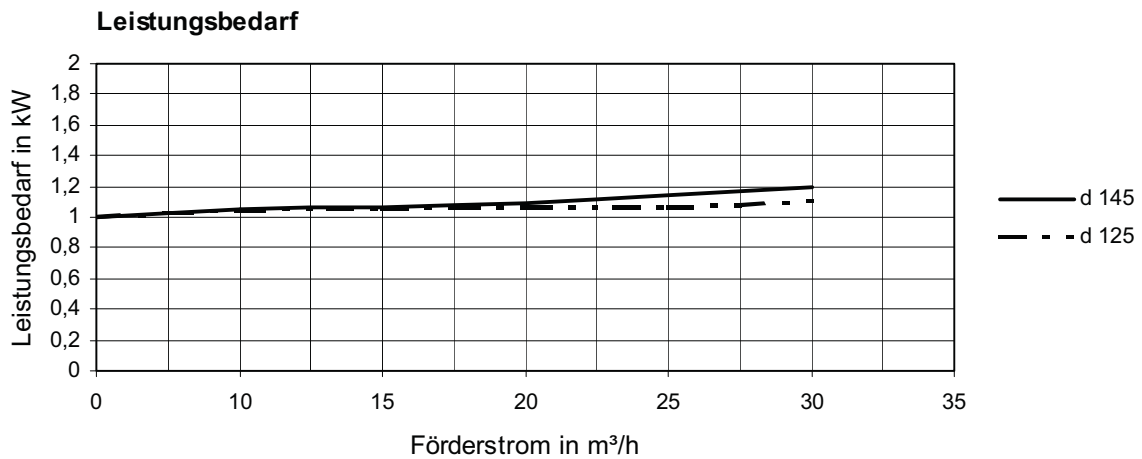
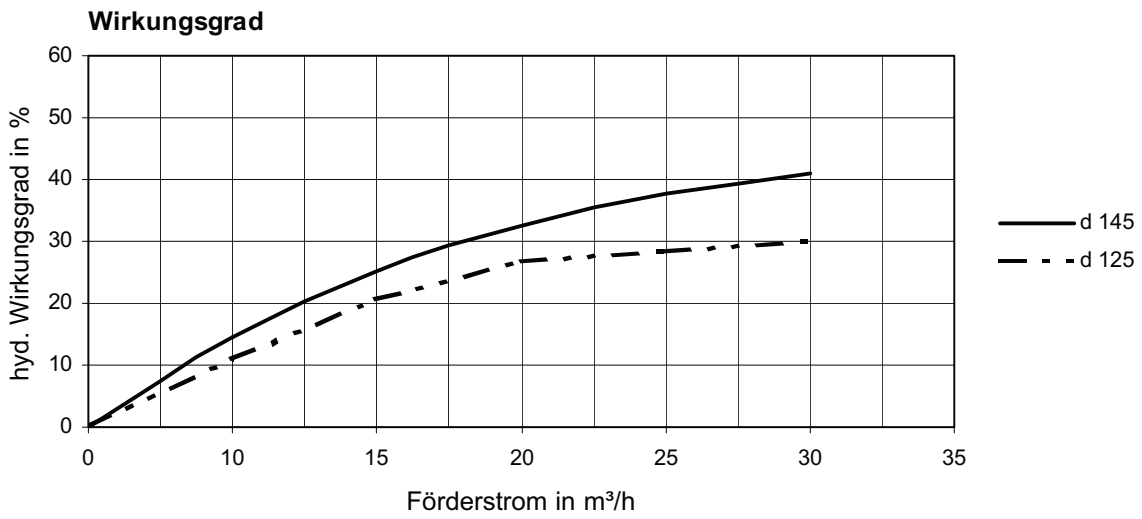
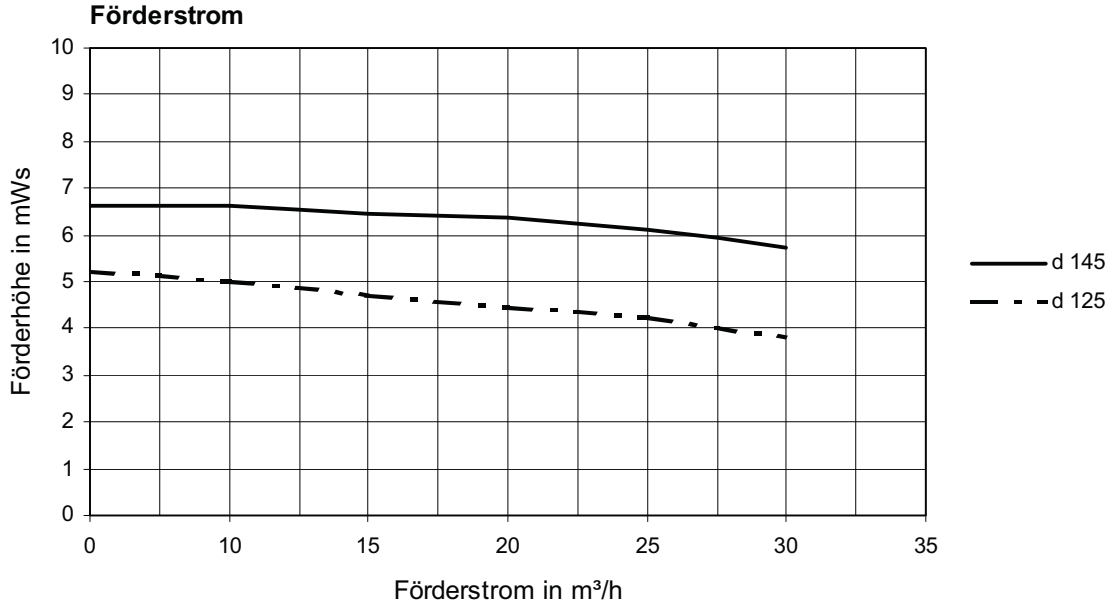

Typ N 80 - 50 - 160

Motor kW: 11
Drehzahl: 2900

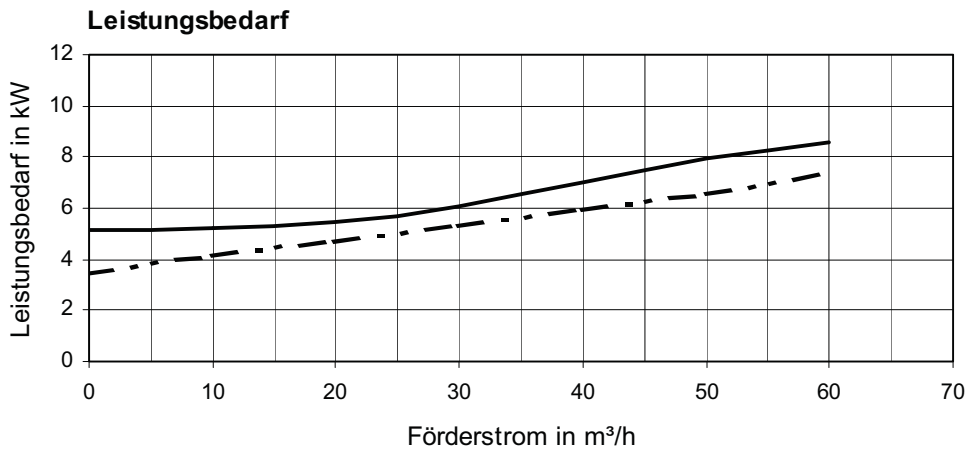
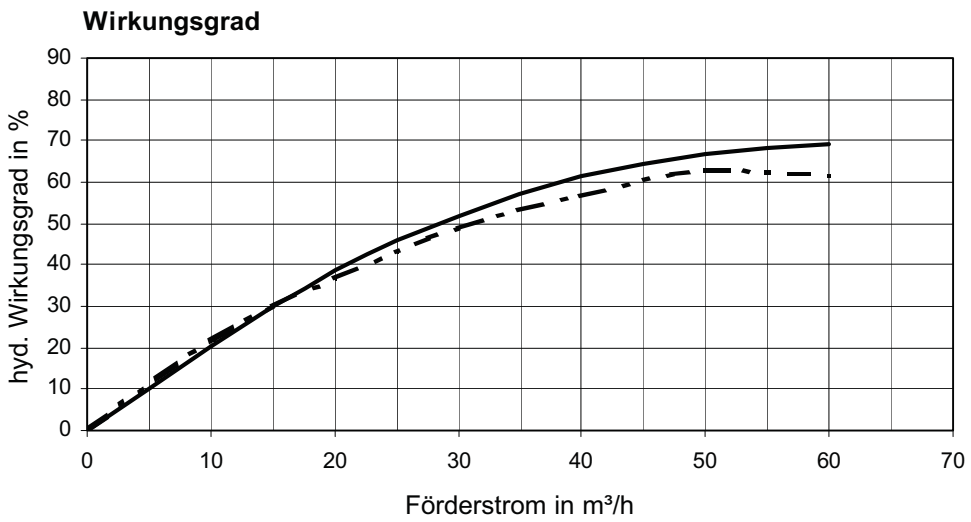
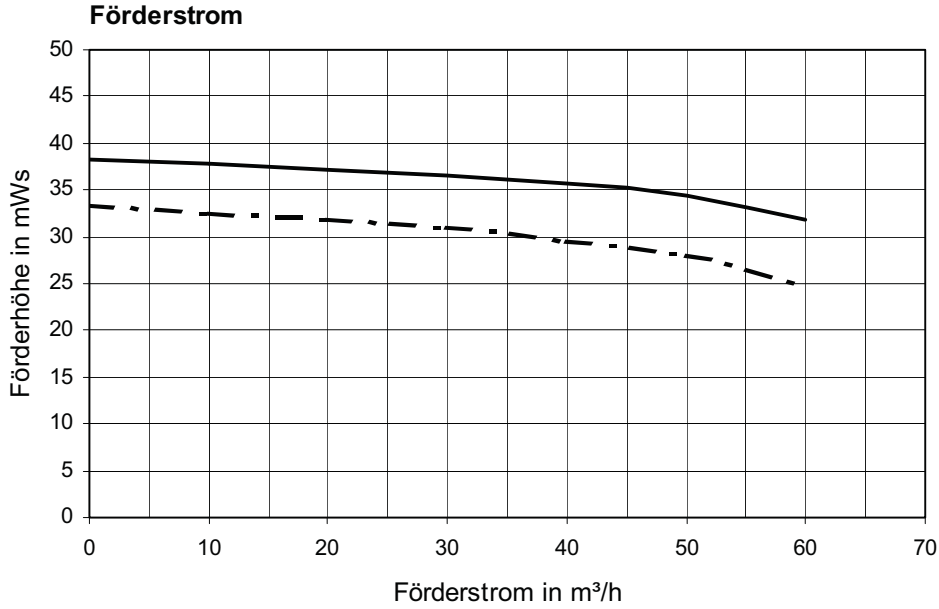

Typ N 80 - 50 - 160

Motor kW: 4
Drehzahl: 1450

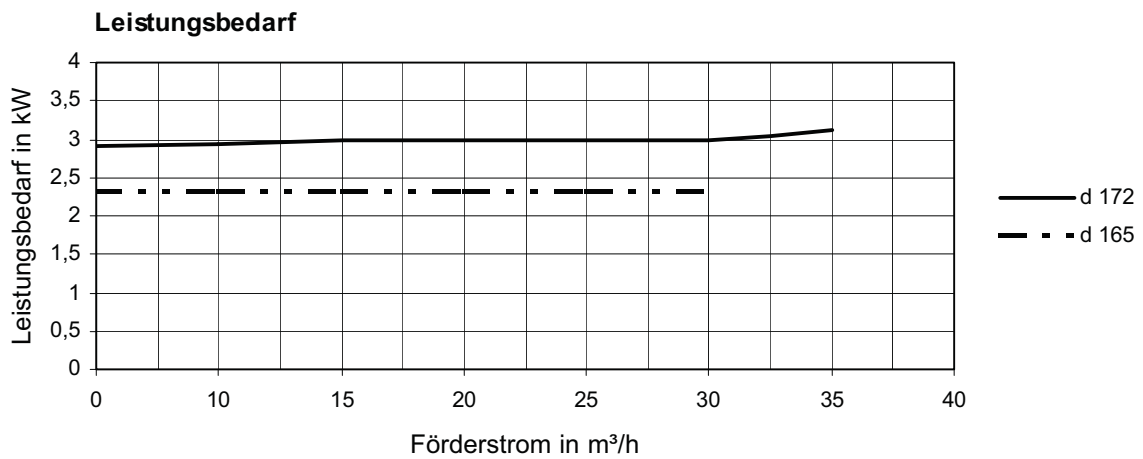
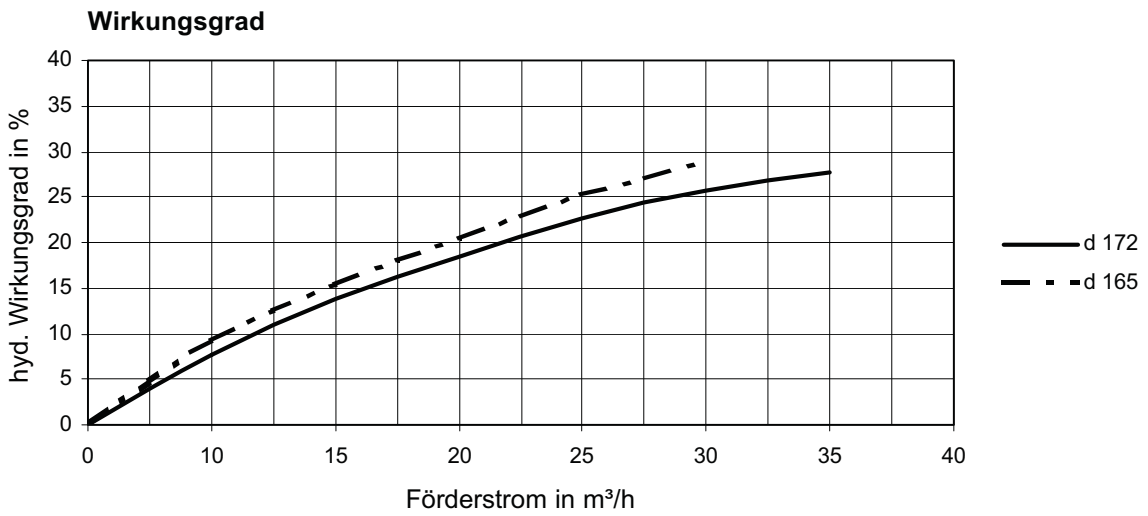
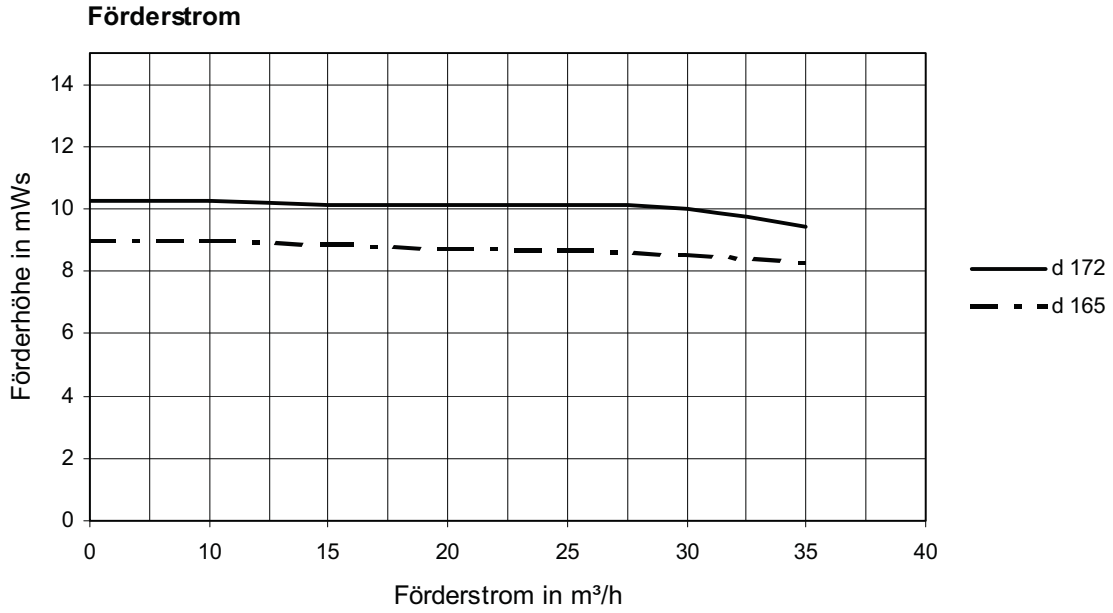

Typ N 80 - 50 - 200

Motor kW: 15
Drehzahl: 2900

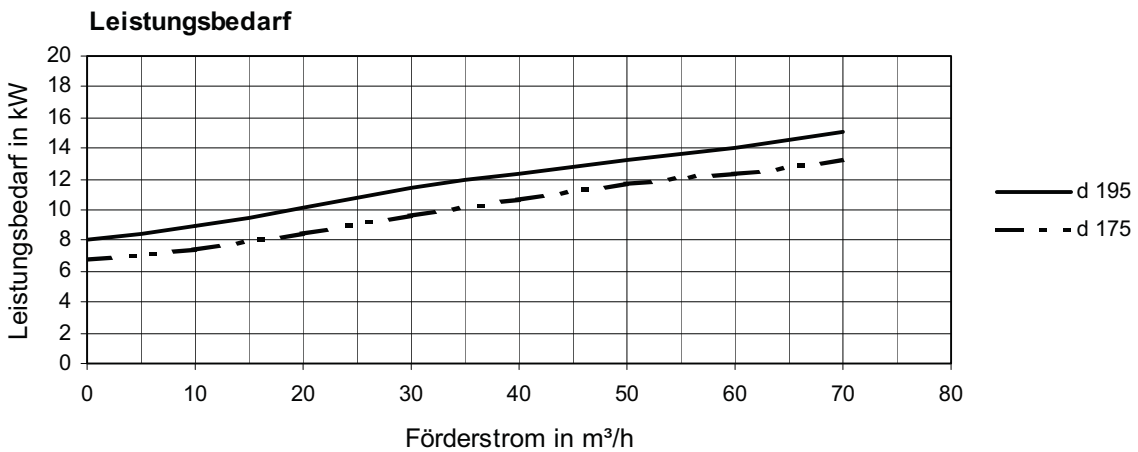
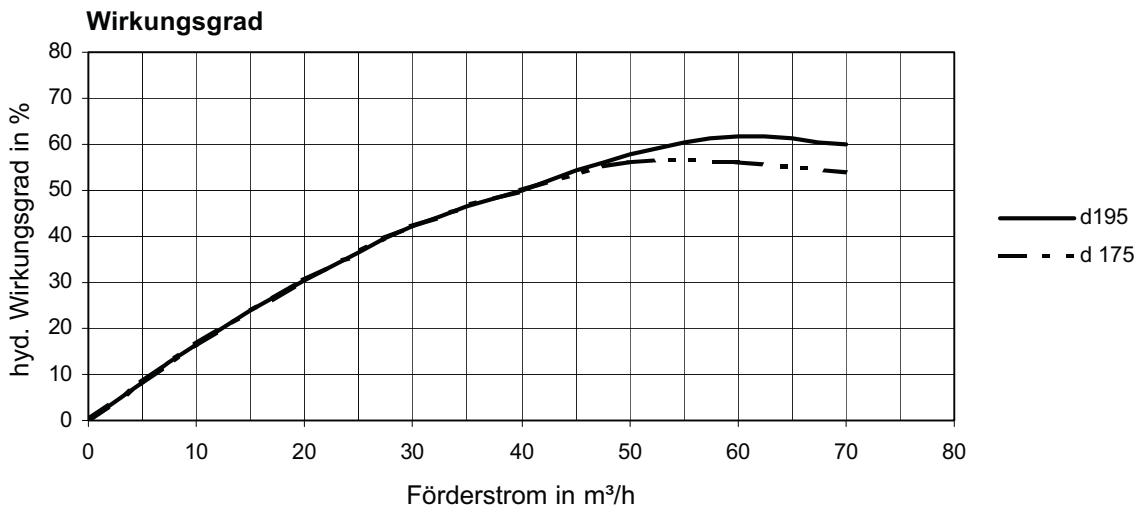
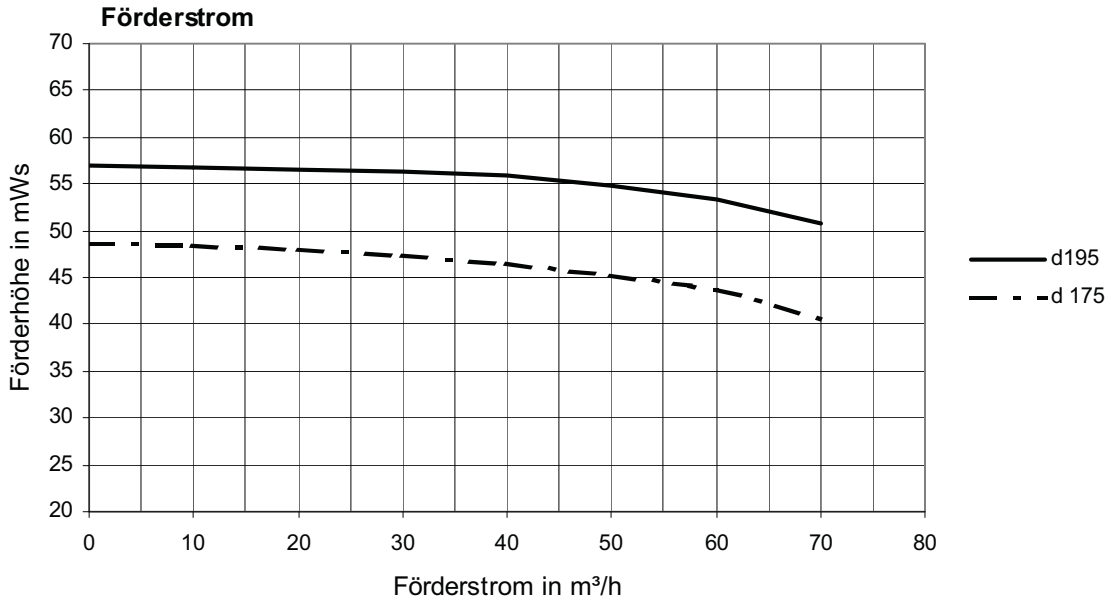

Typ N 80 - 50 - 200

Motor kW: 3
Drehzahl: 1450

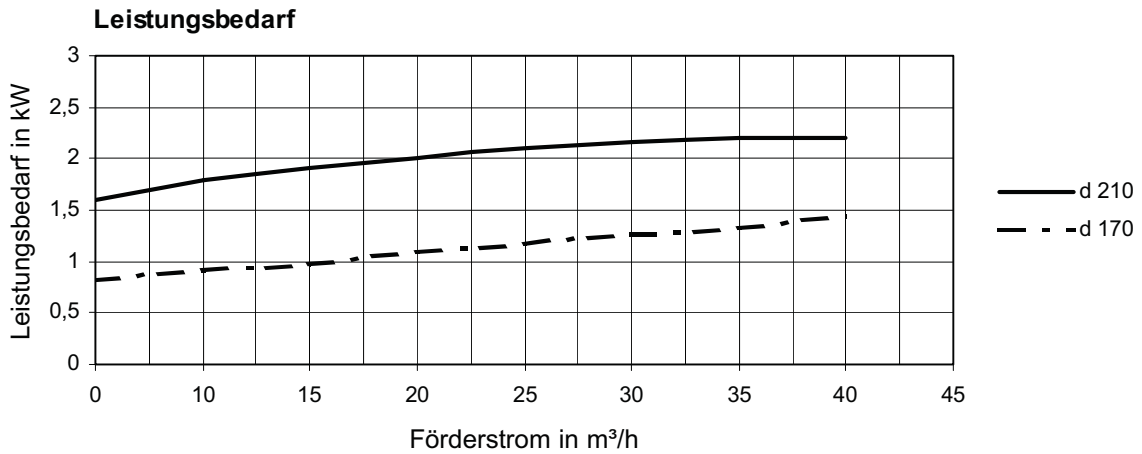
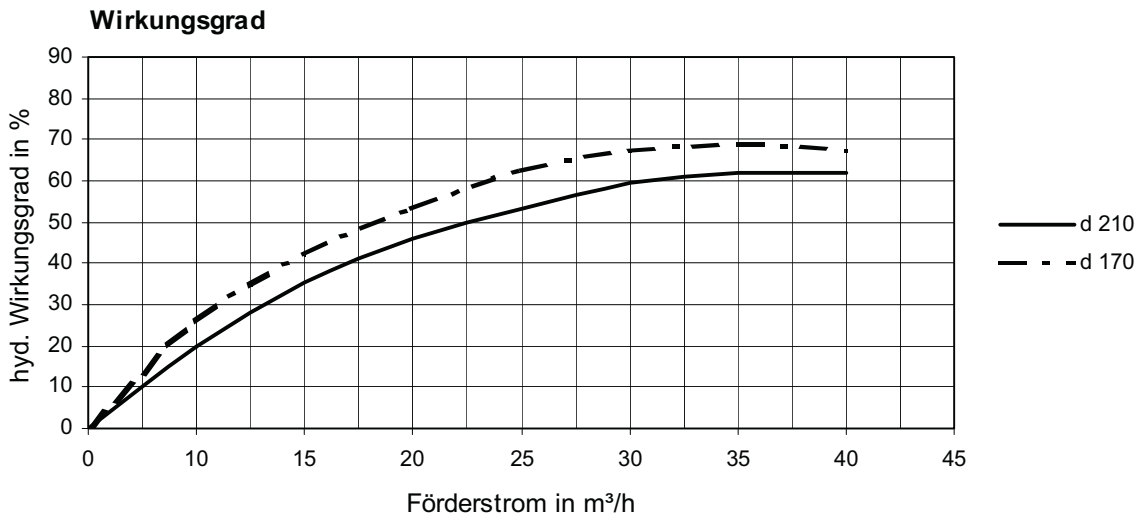
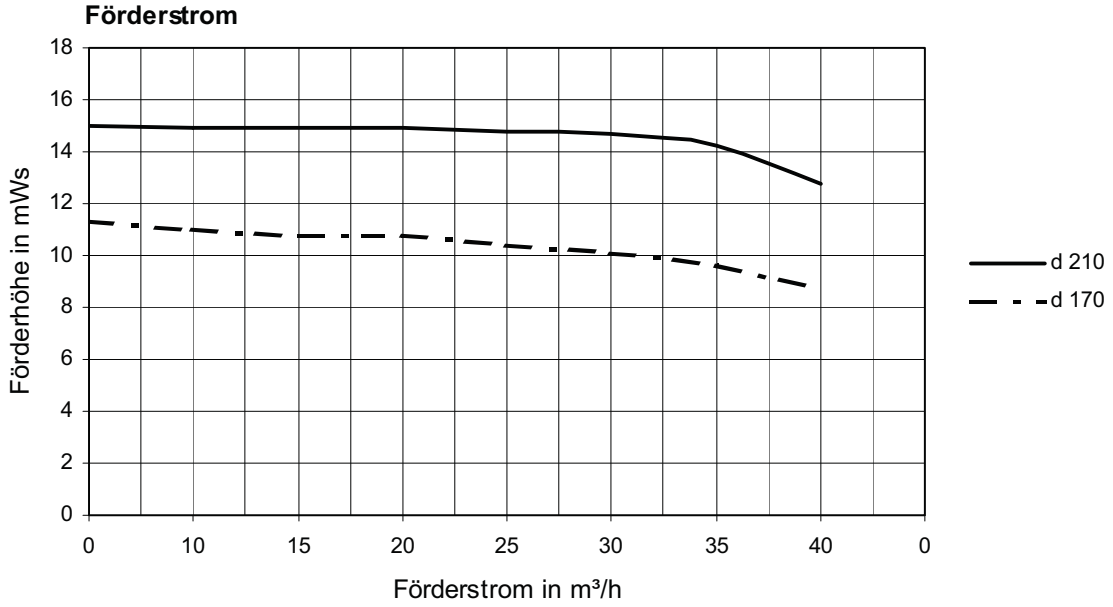

Typ N 80 - 50 - 250

Motor kW: 22
Drehzahl: 2900

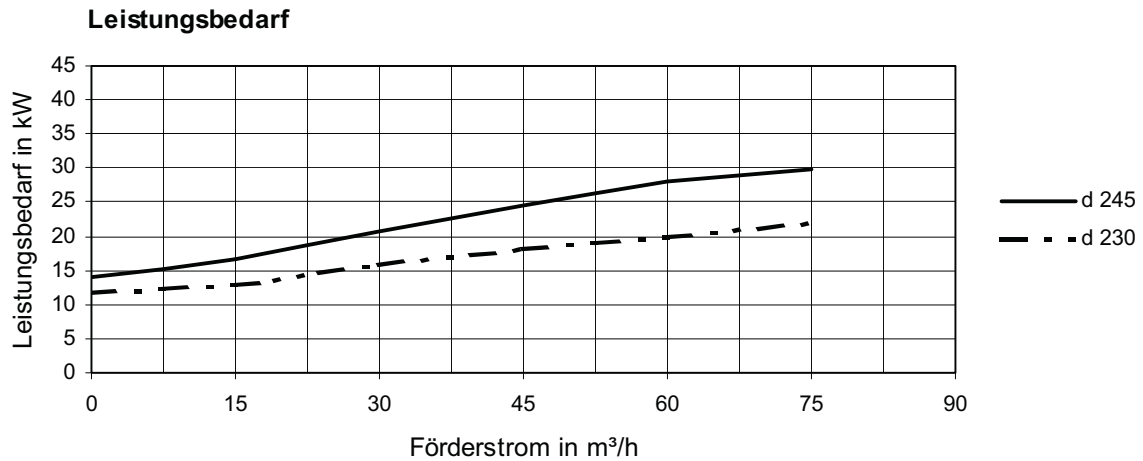
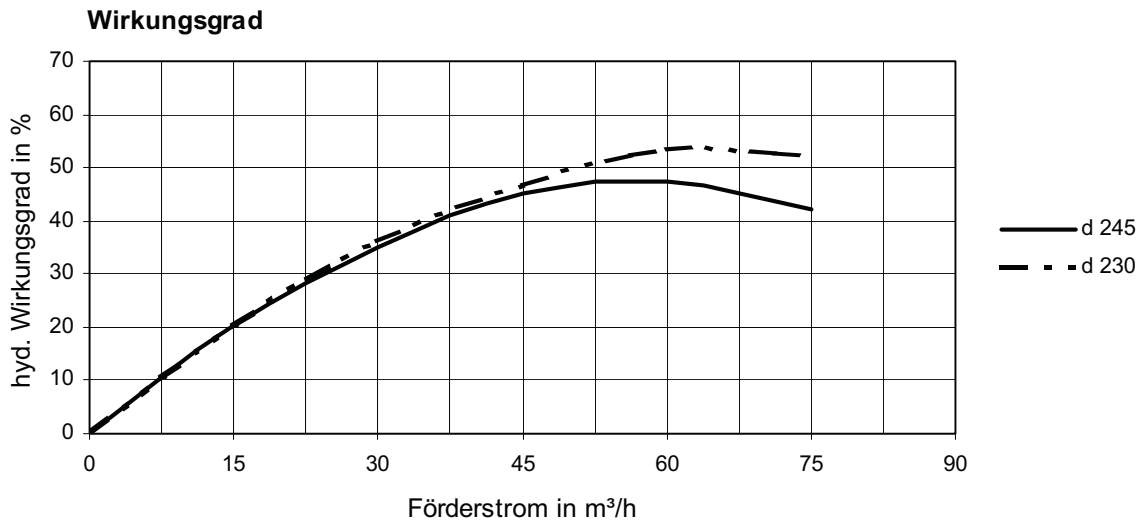
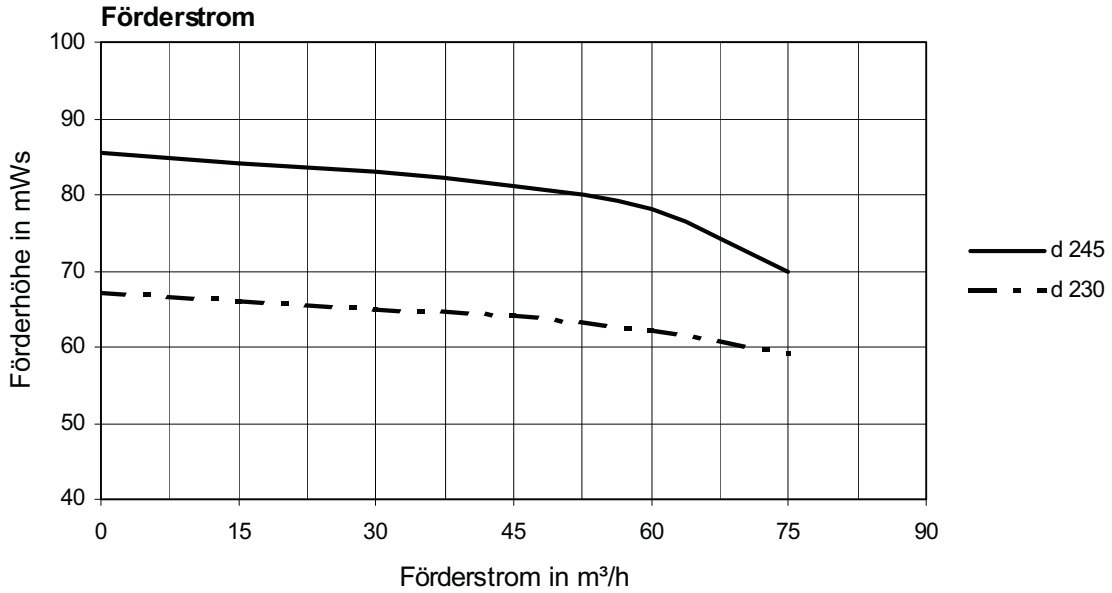

Typ N 80 - 50 - 250

Motor kW: 5,5
Drehzahl: 1450

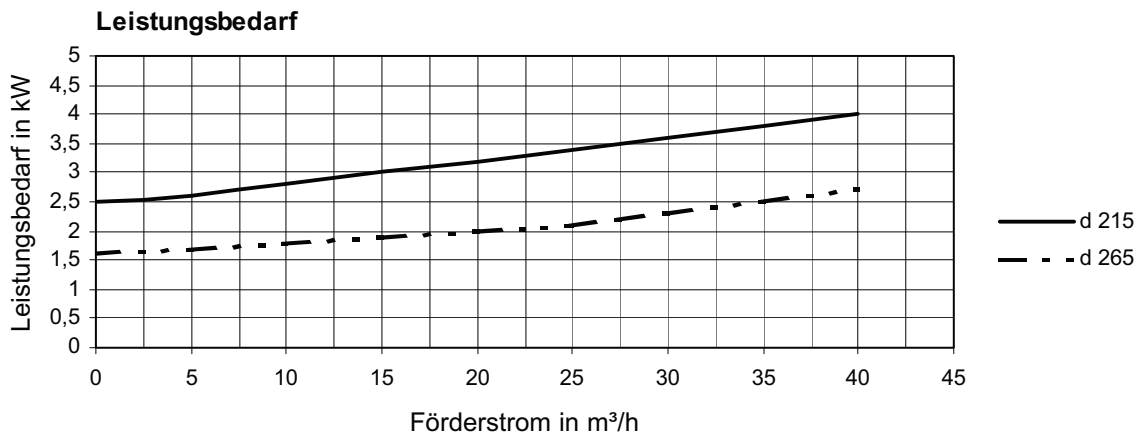
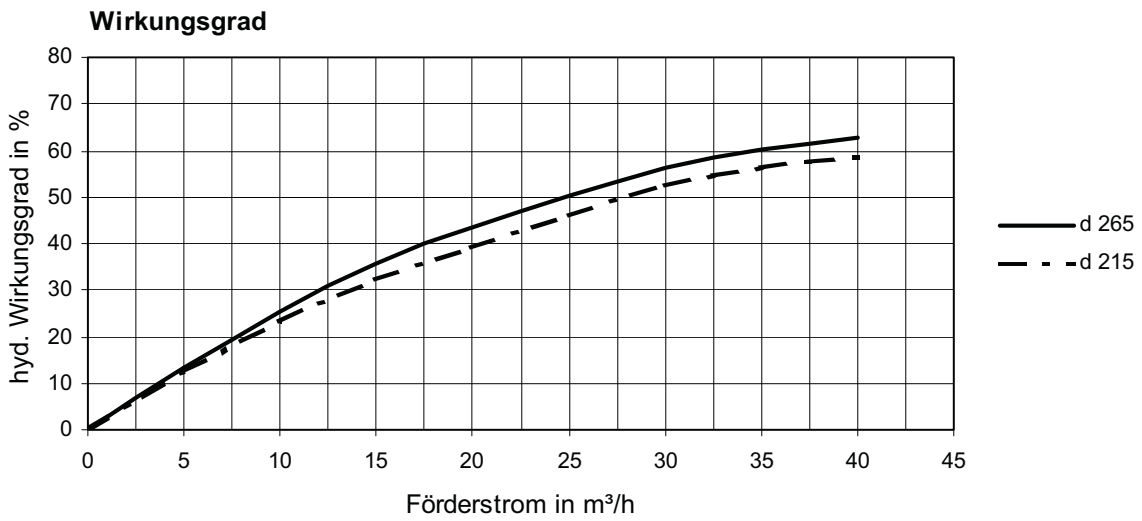
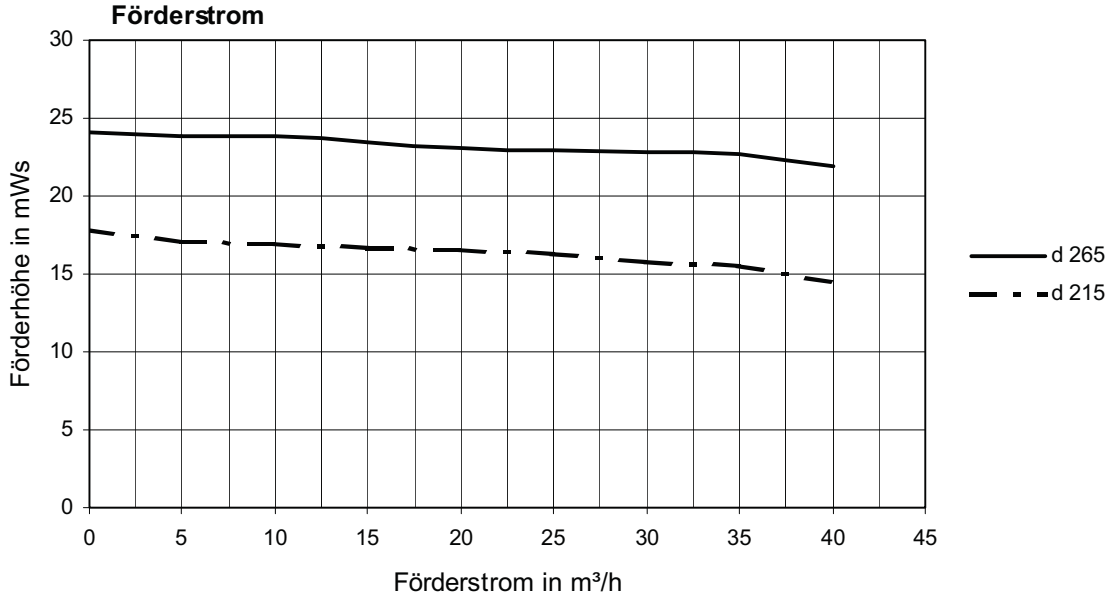

Typ N 80 - 50 - 315

Motor kW: 7,5
Drehzahl: 1450

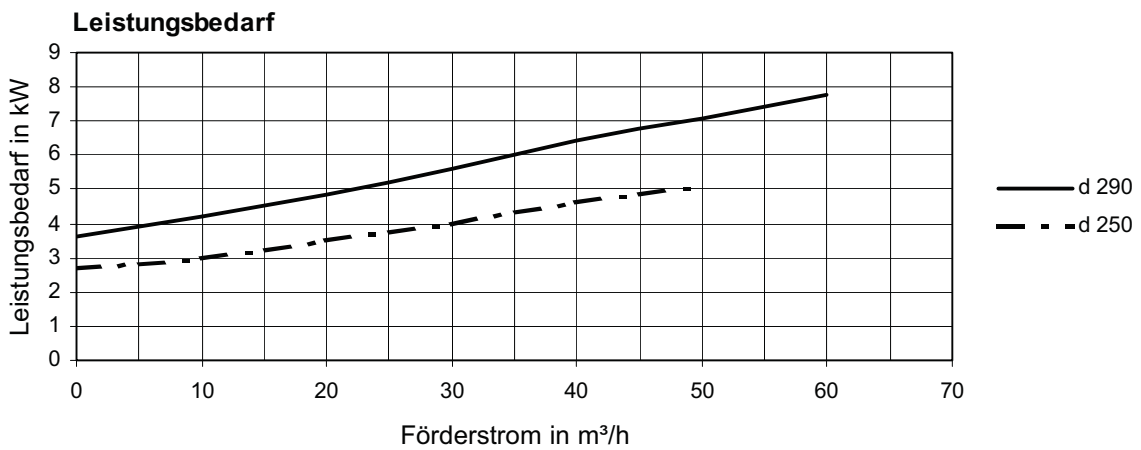
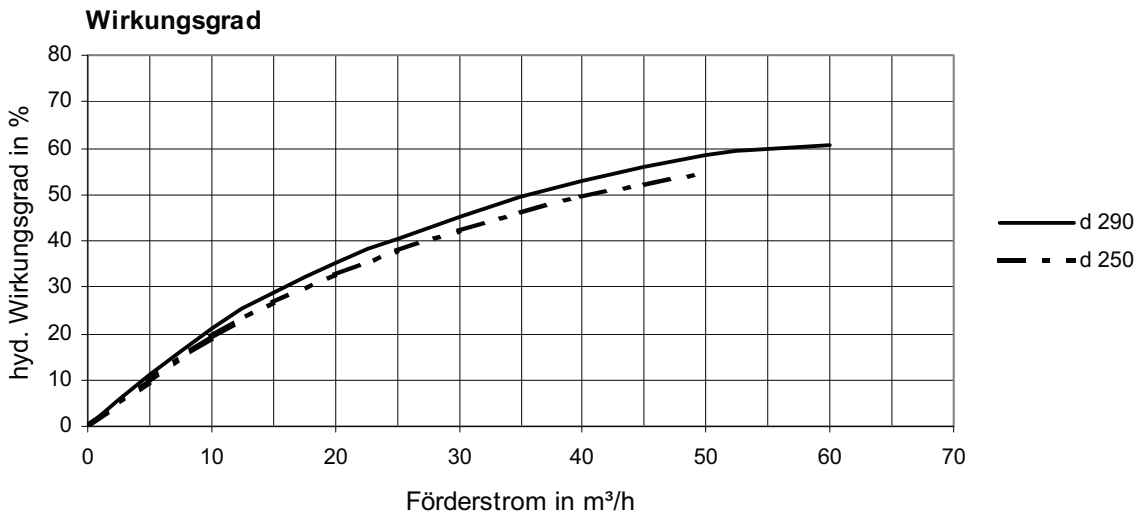
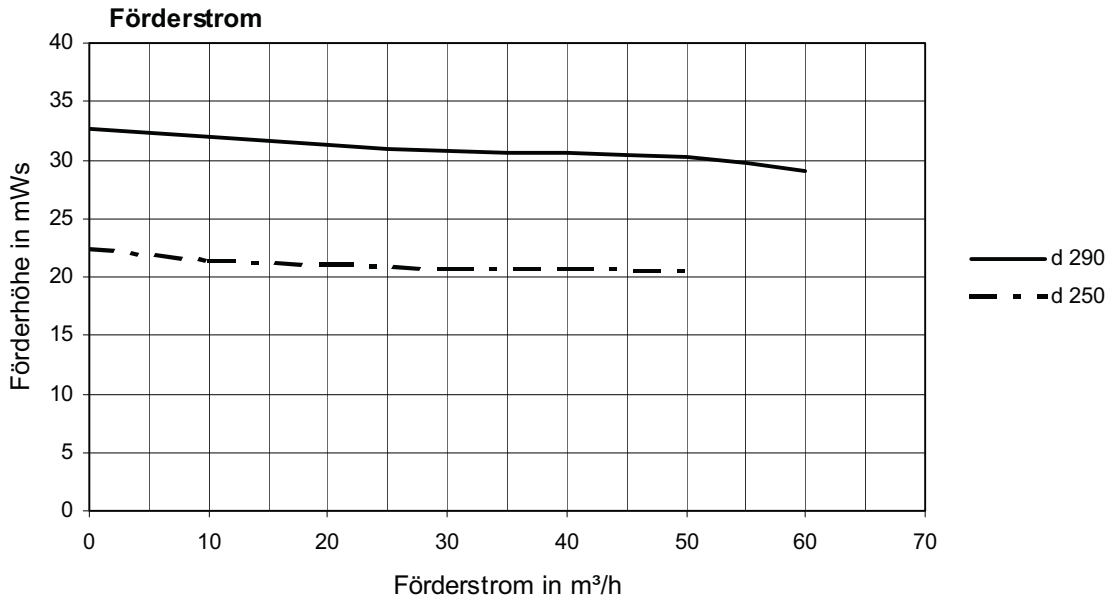

Chemie-Normpumpe N

Chemie-Normpumpe N

Typ N 100 - 65 - 125

Motor kW: 11
Drehzahl: 2900

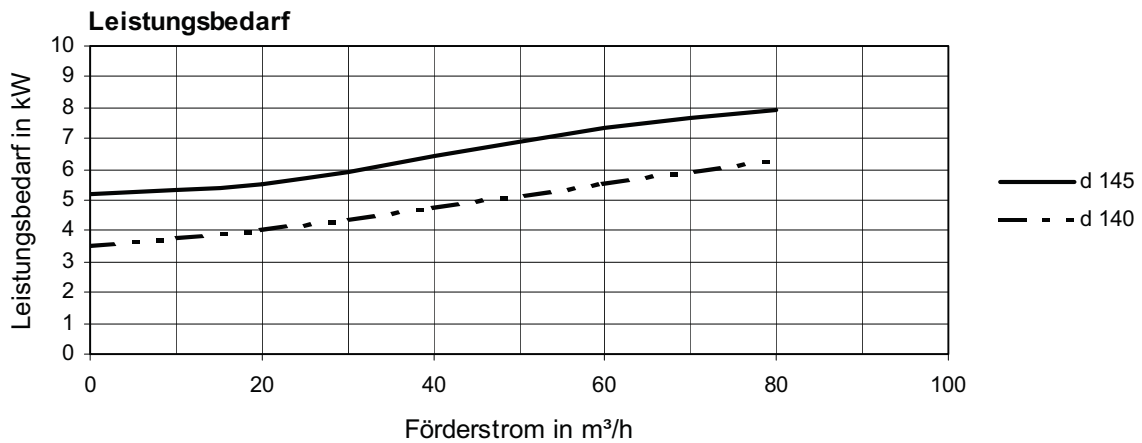
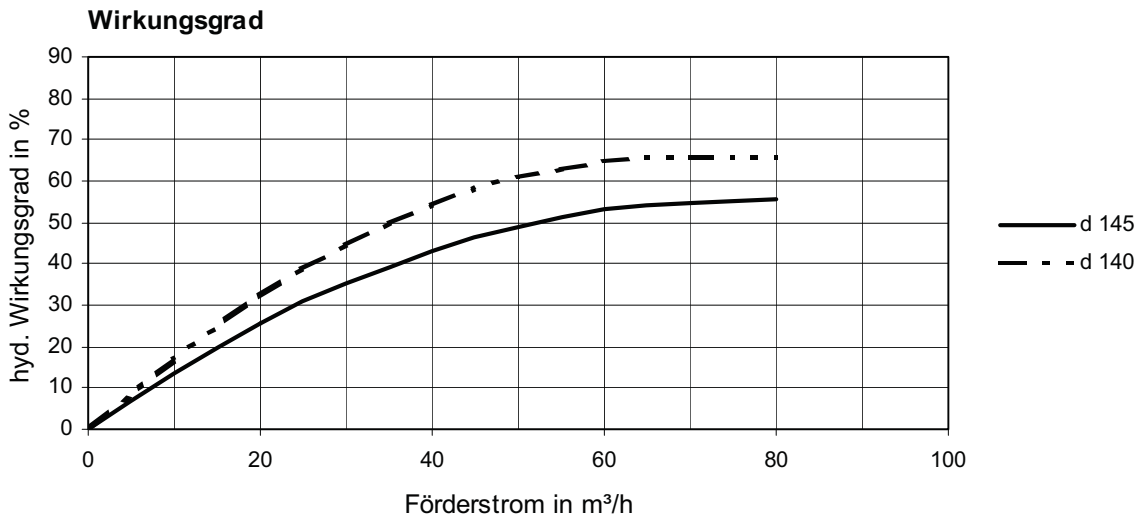
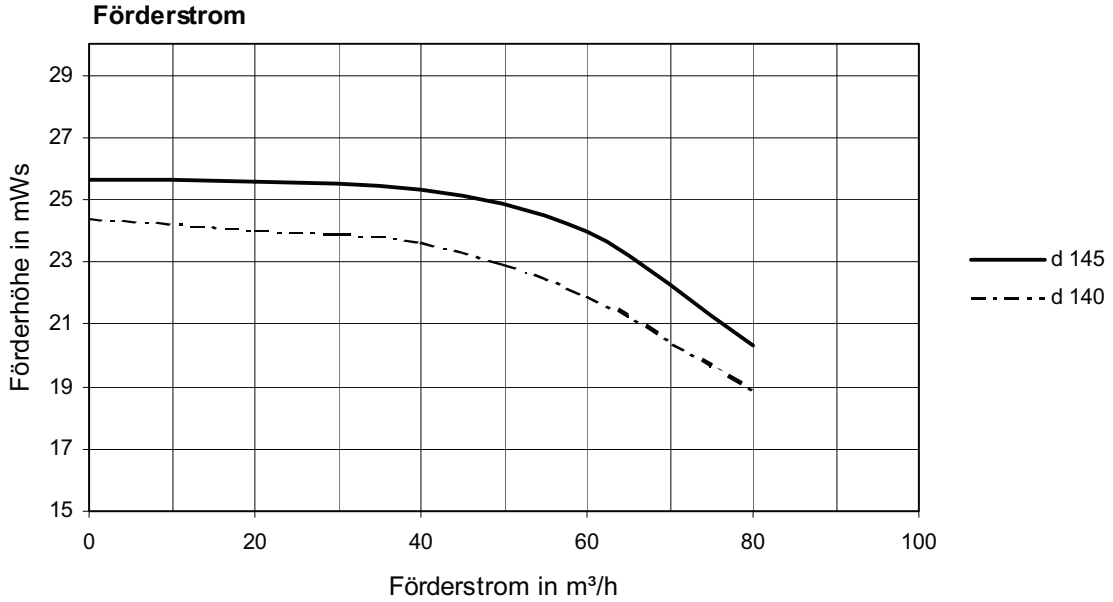

Chemie-Normpumpe N

Typ N 100 - 65 - 125

Motor kW: 5,5
Drehzahl: 1450

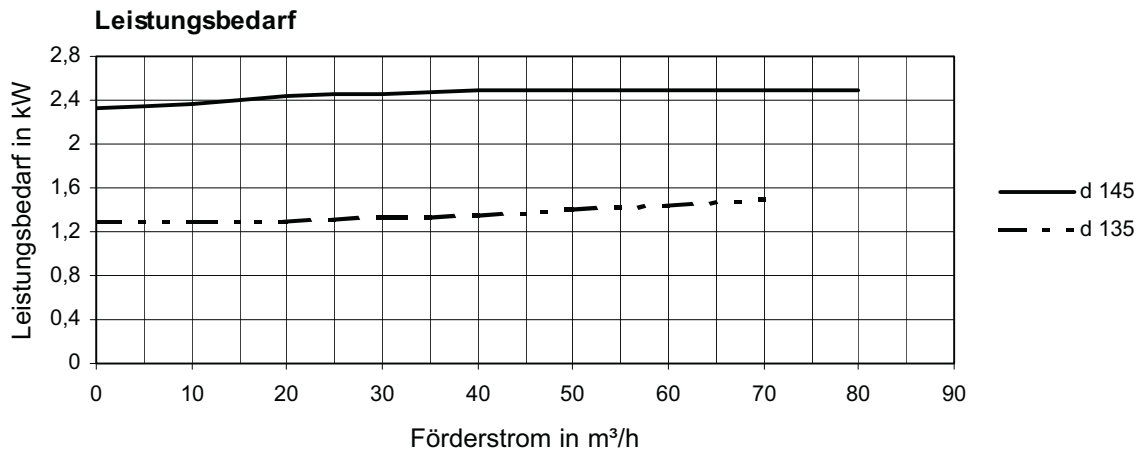
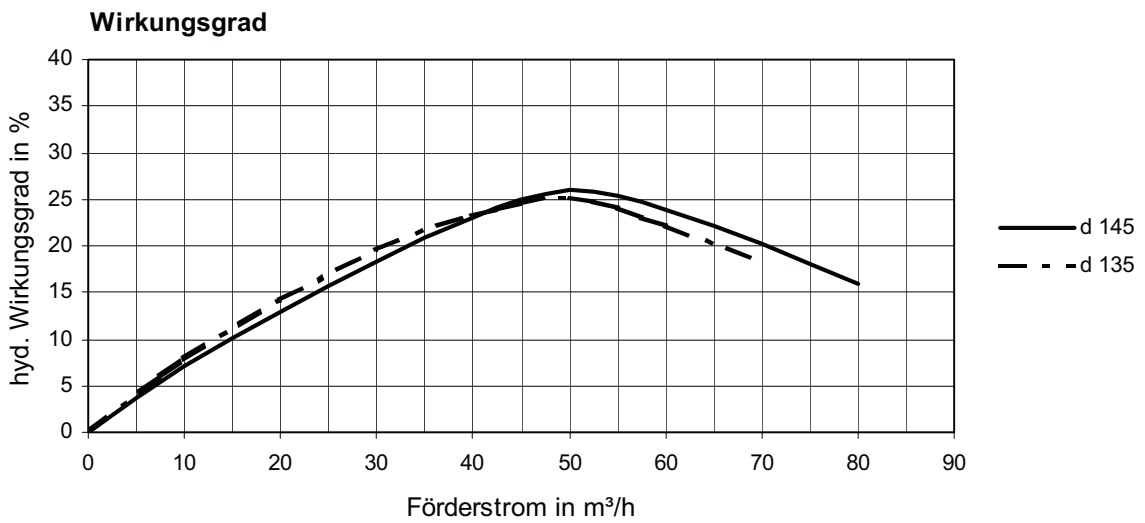
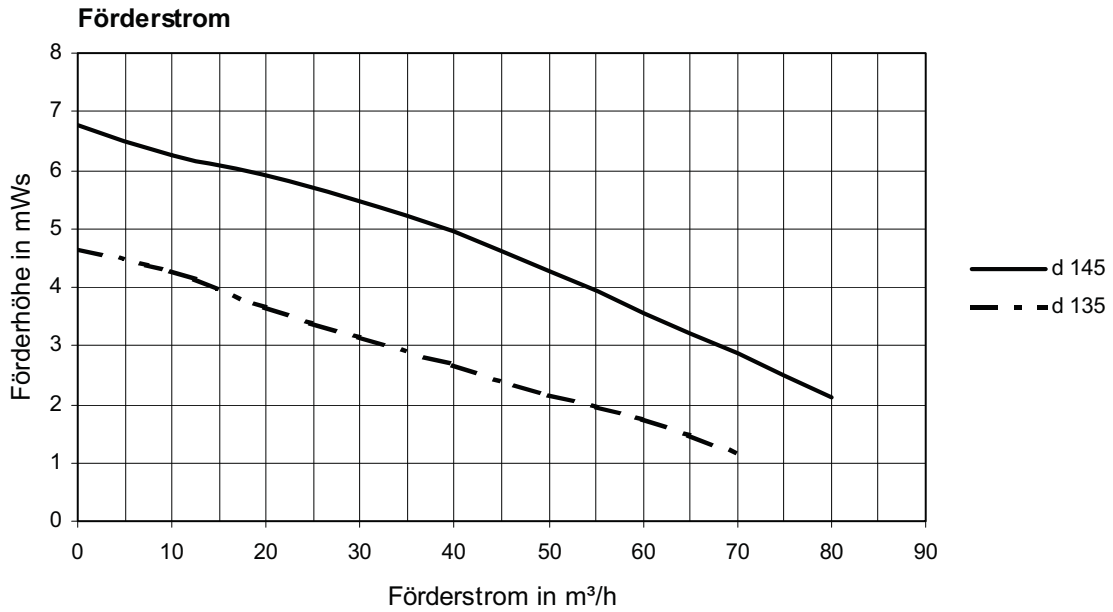

Typ N 100 - 65 - 160

Motor kW: 15
Drehzahl: 2900

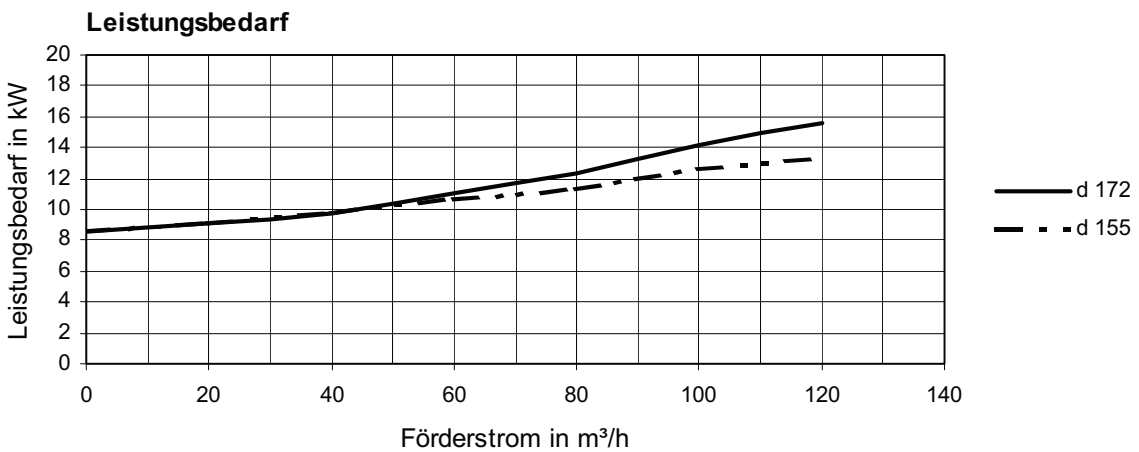
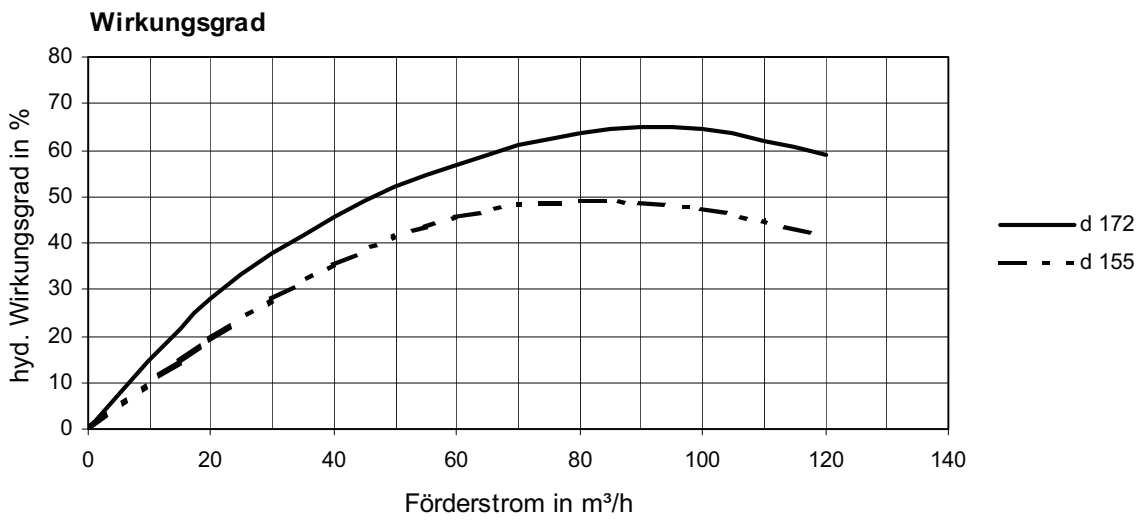
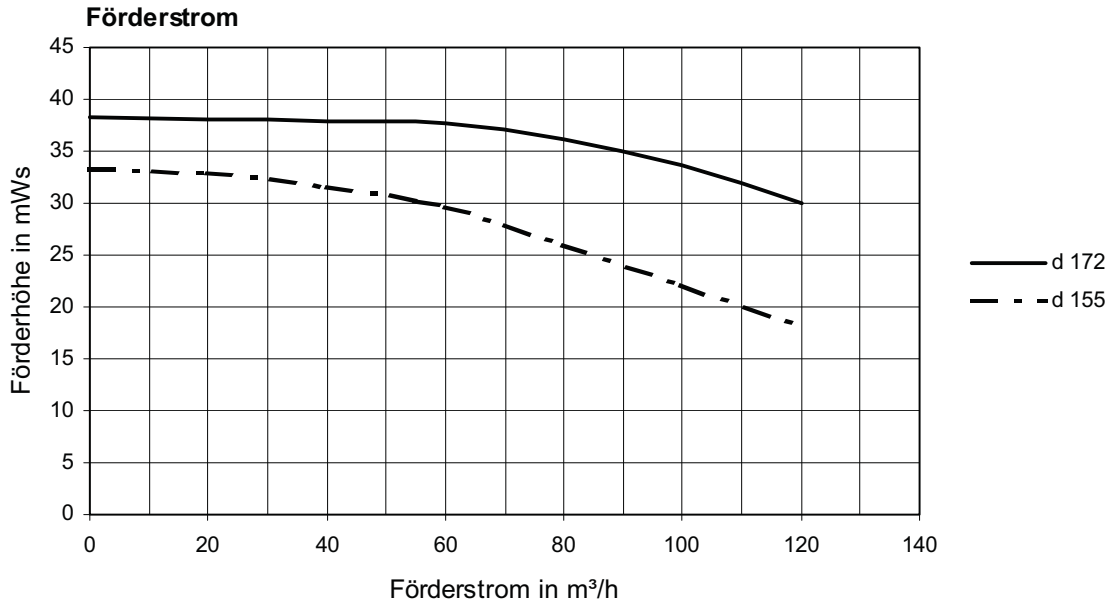

Chemie-Normpumpe N

Typ N 100 - 65 - 160

Motor kW: 3
Drehzahl: 1450

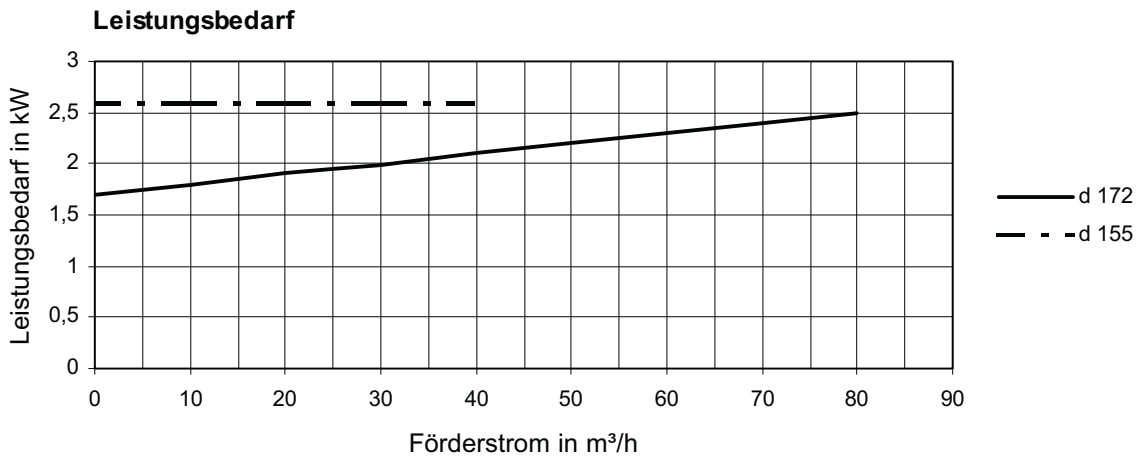
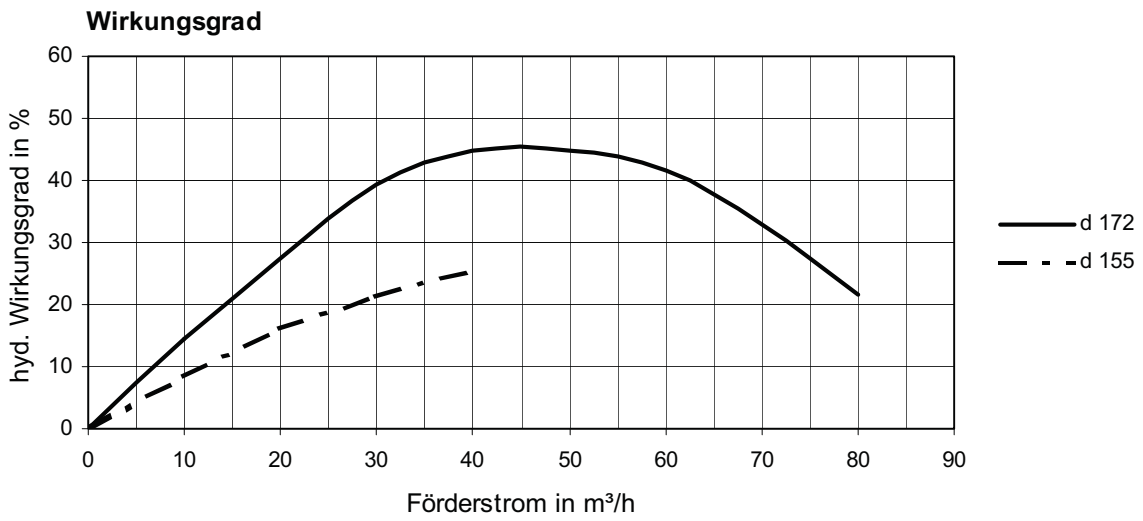
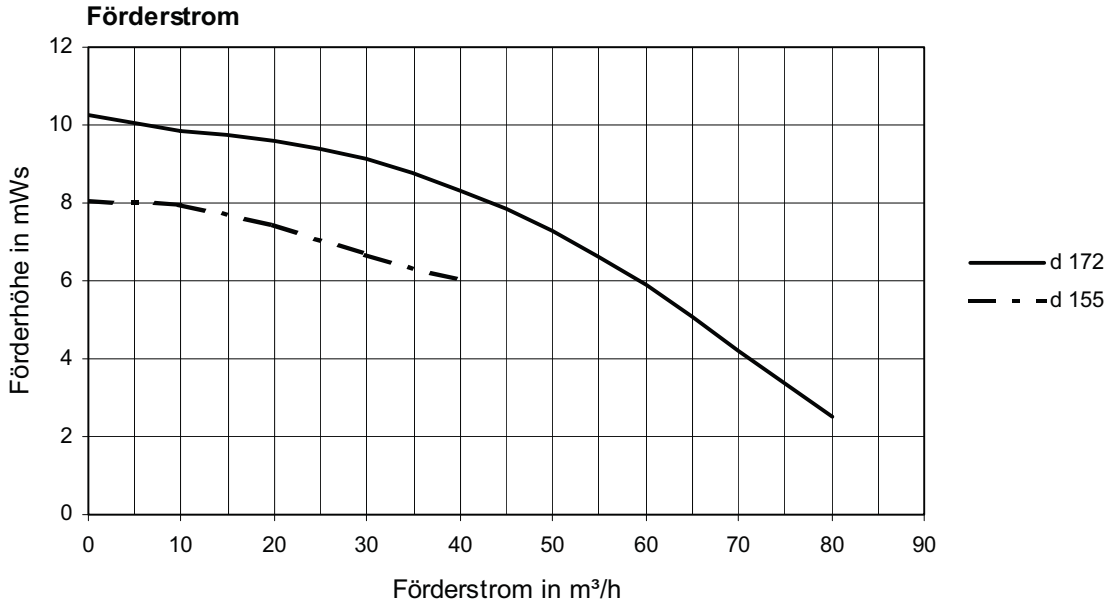

Chemie-Normpumpe N

Typ N 100 - 65 - 200

Motor kW: 22
Drehzahl: 2900

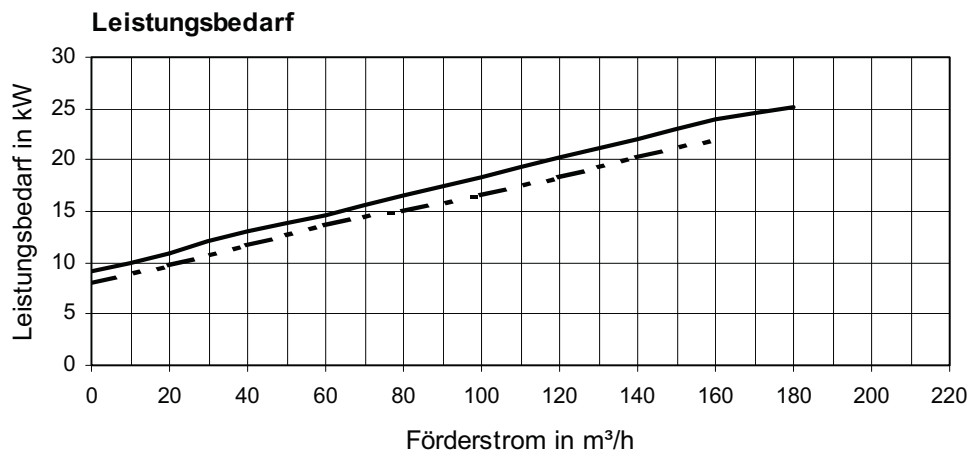
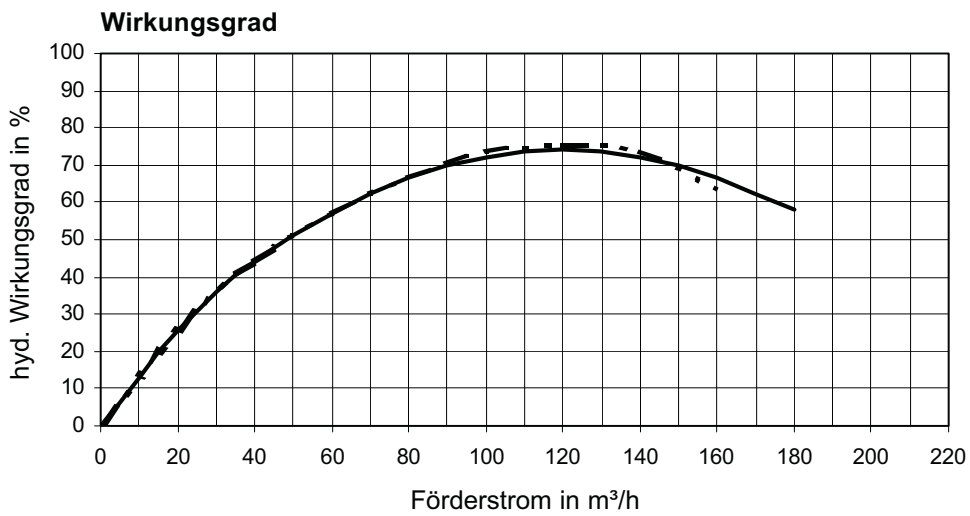
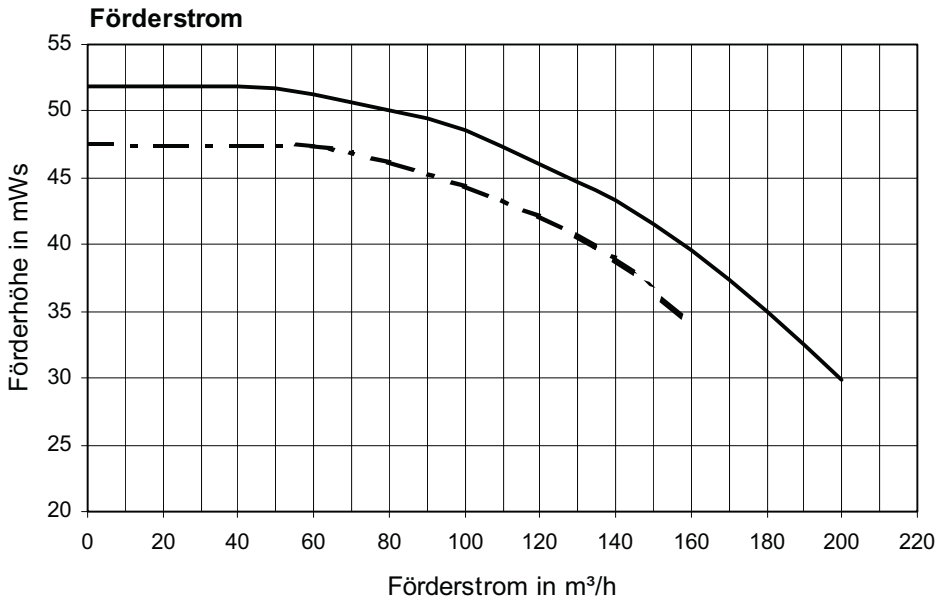

Chemie-Normpumpe N

Typ N 100 - 65 - 200

Motor kW: 4
Drehzahl: 1450

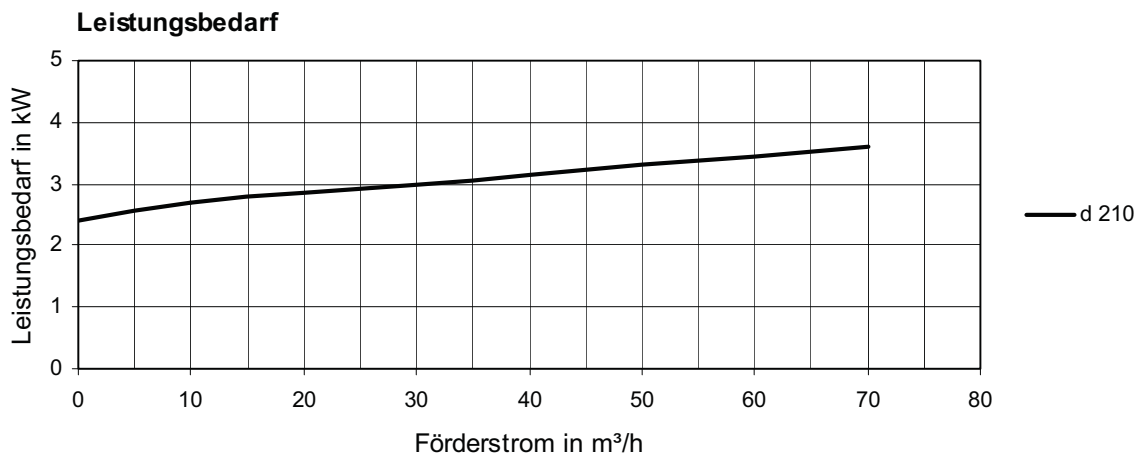
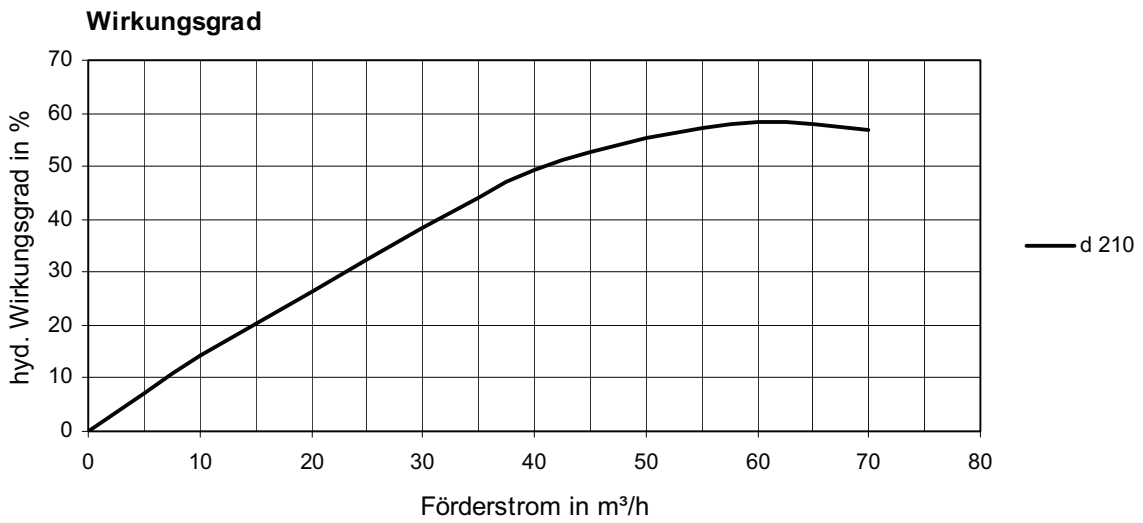
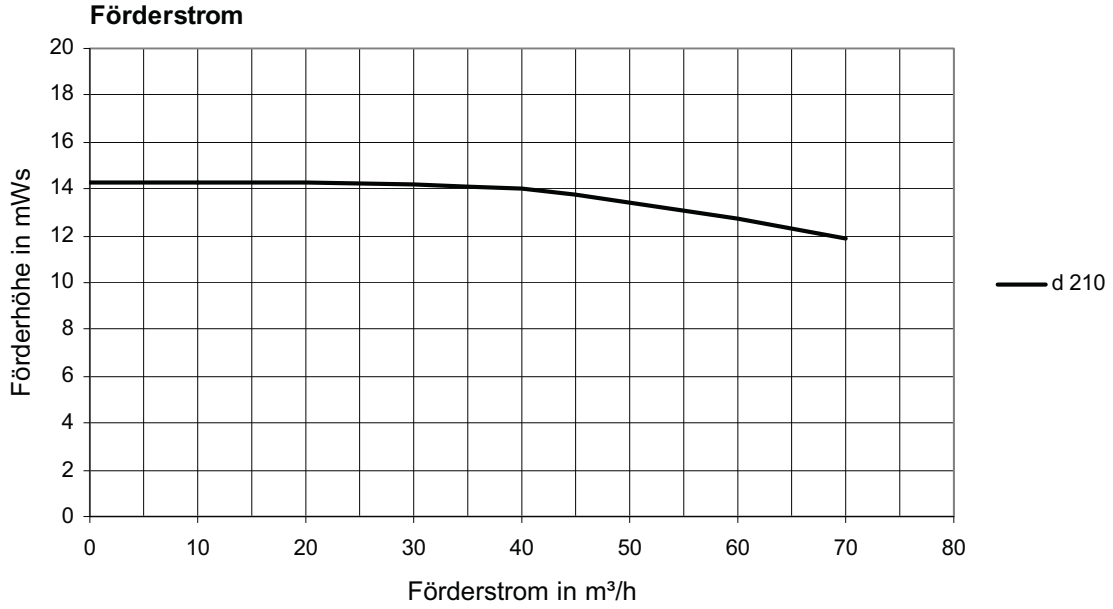

Typ N 100 - 65 - 250

Motor kW: 30
Drehzahl: 2900

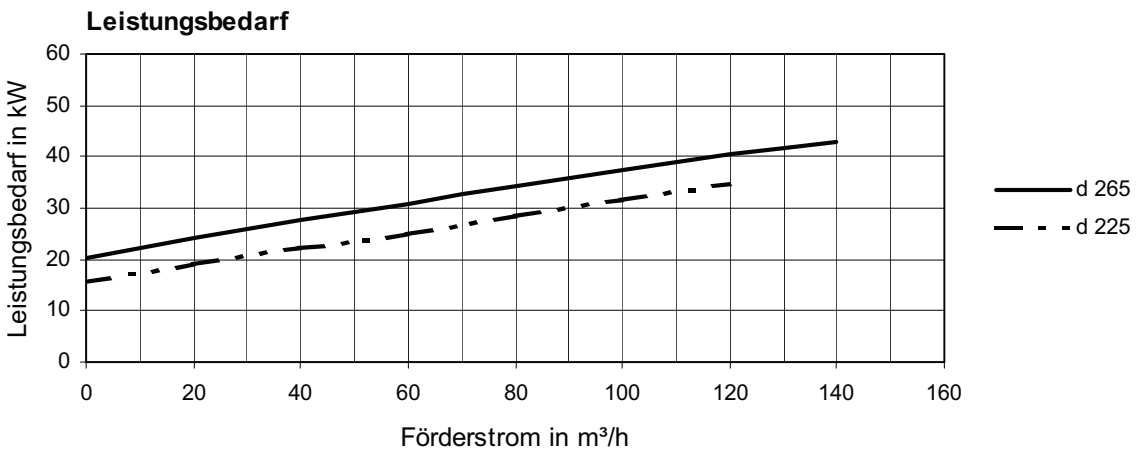
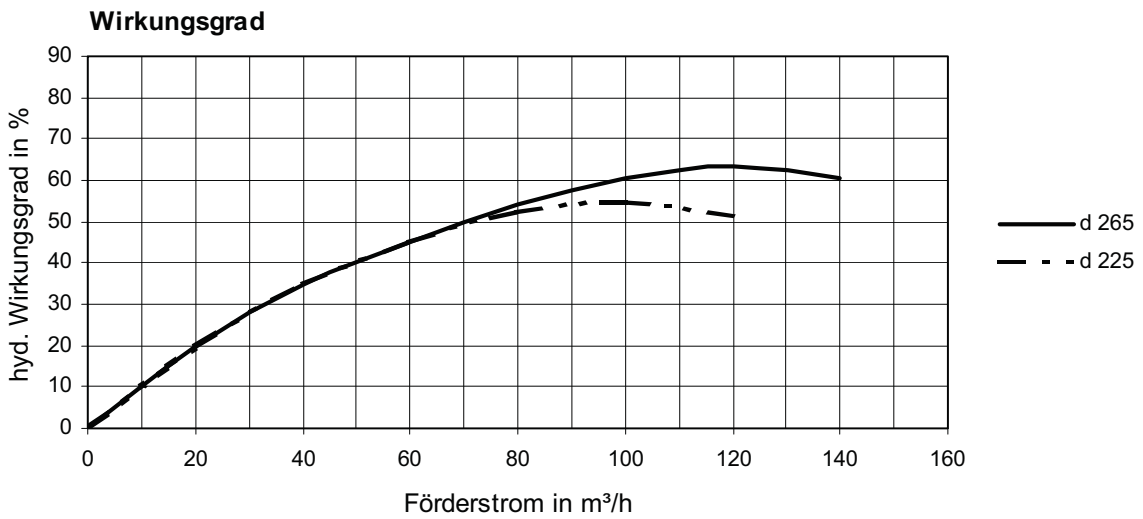
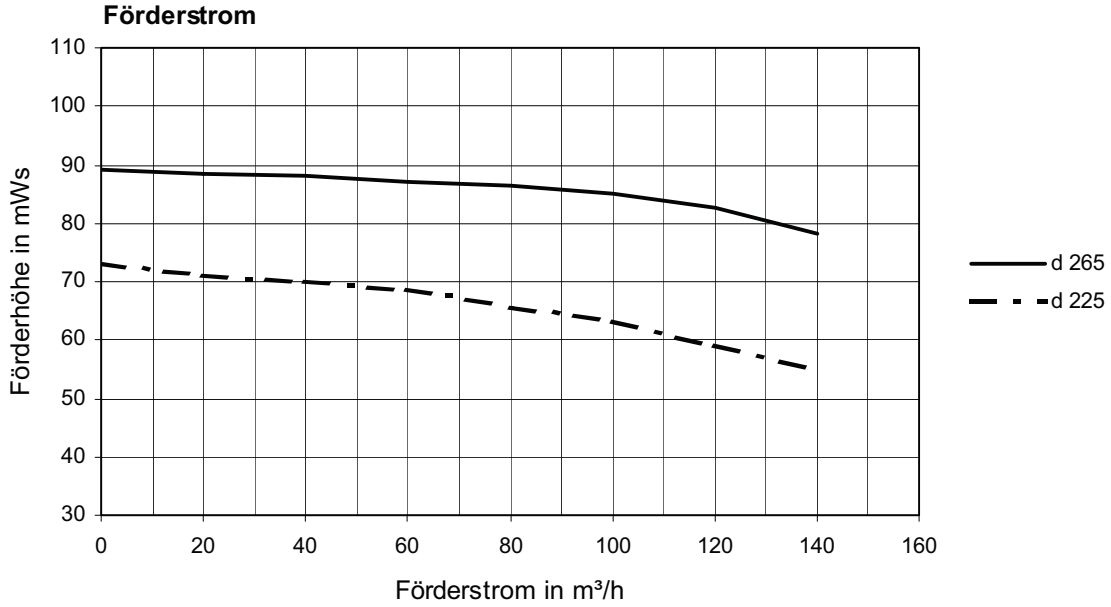

Chemie-Normpumpe N

Typ N 100 - 65 - 250

Motor kW: 5,5
Drehzahl: 1450

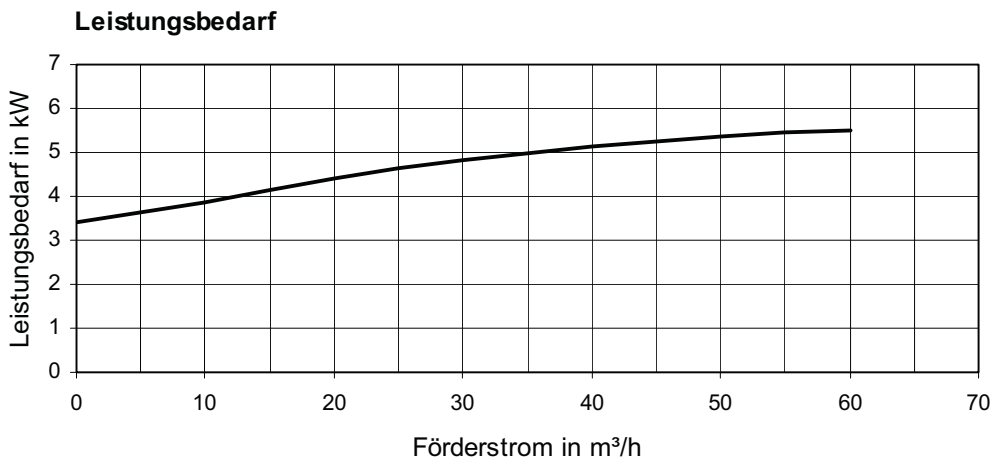
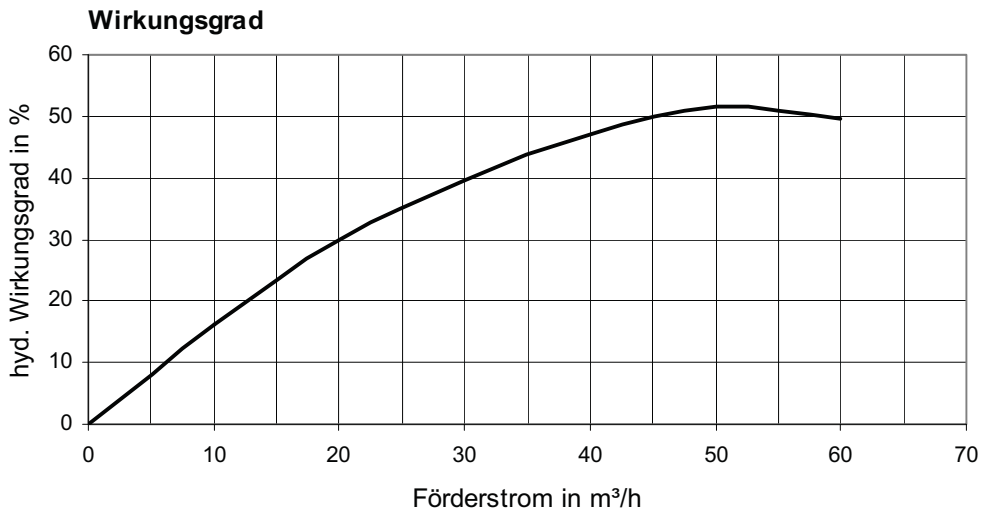
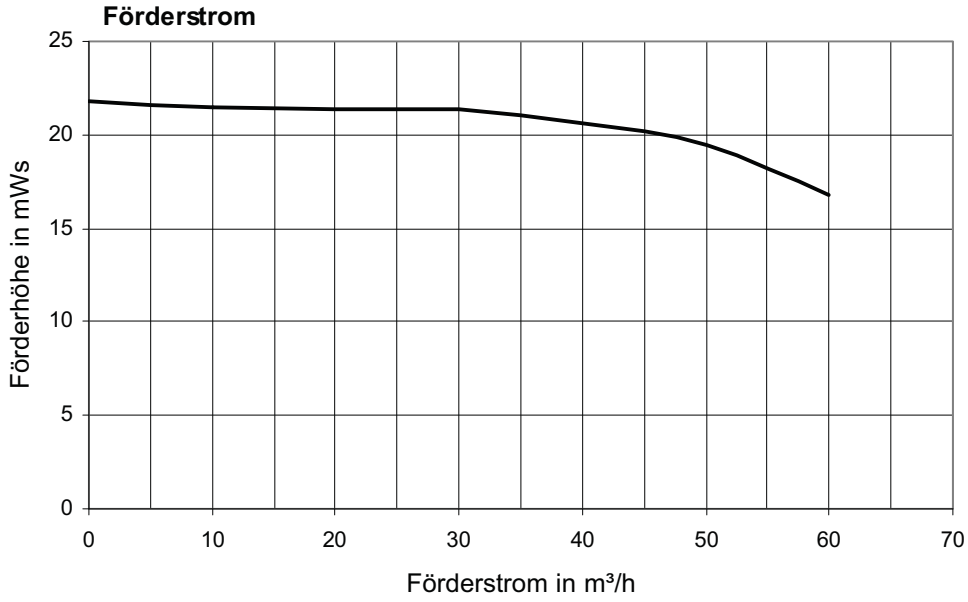

Typ N 100 - 65 - 315

Motor kW: 18,5
Drehzahl: 1450

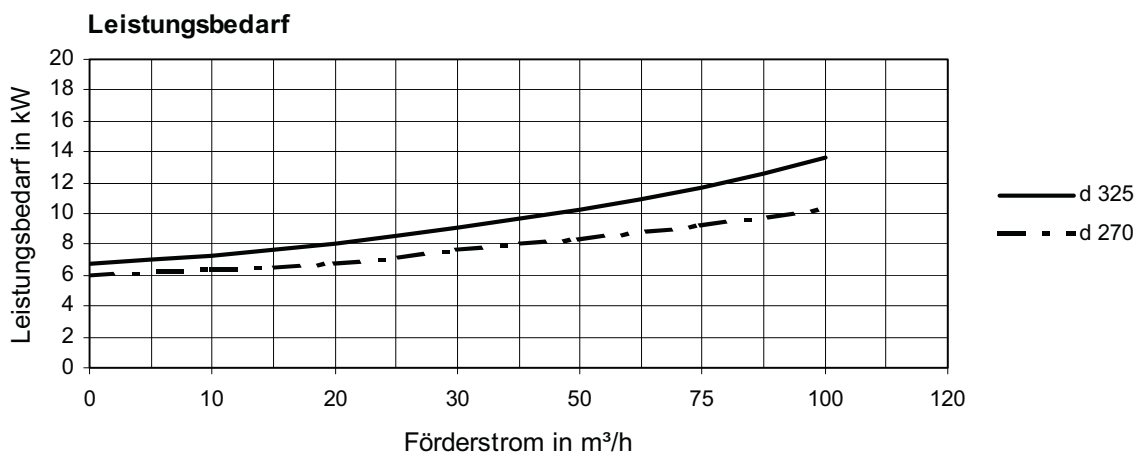
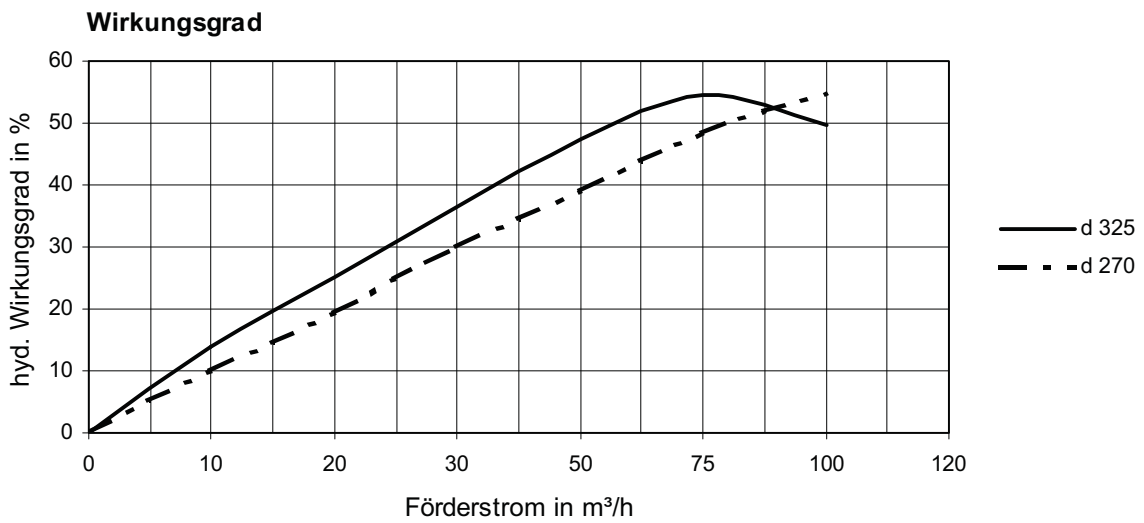
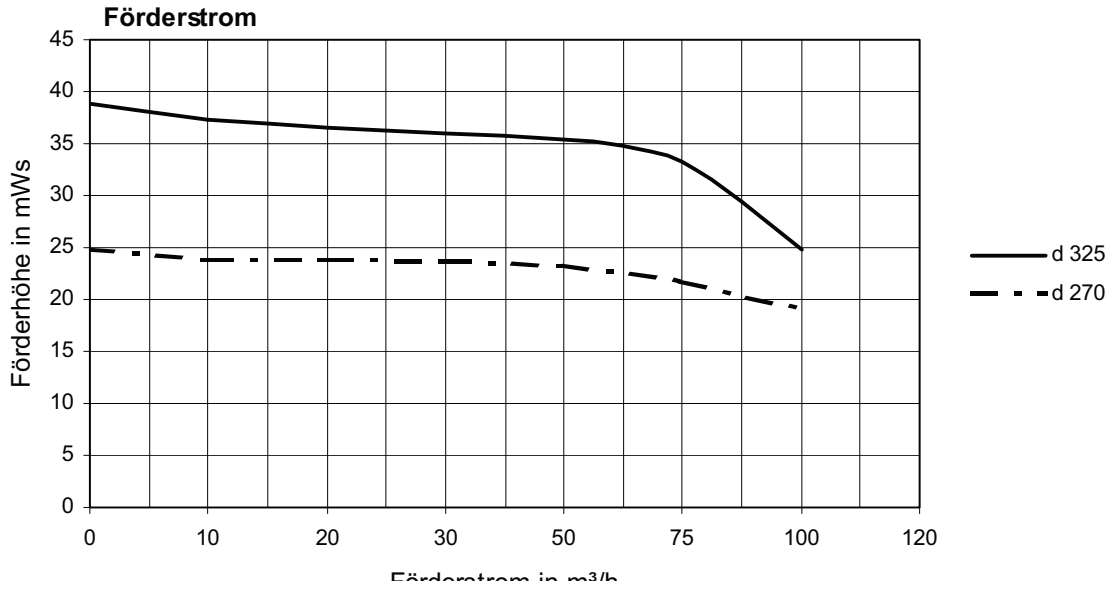

Chemie-Normpumpe N

Typ N 125 - 80 - 160

Motor kW: 15
Drehzahl: 2900

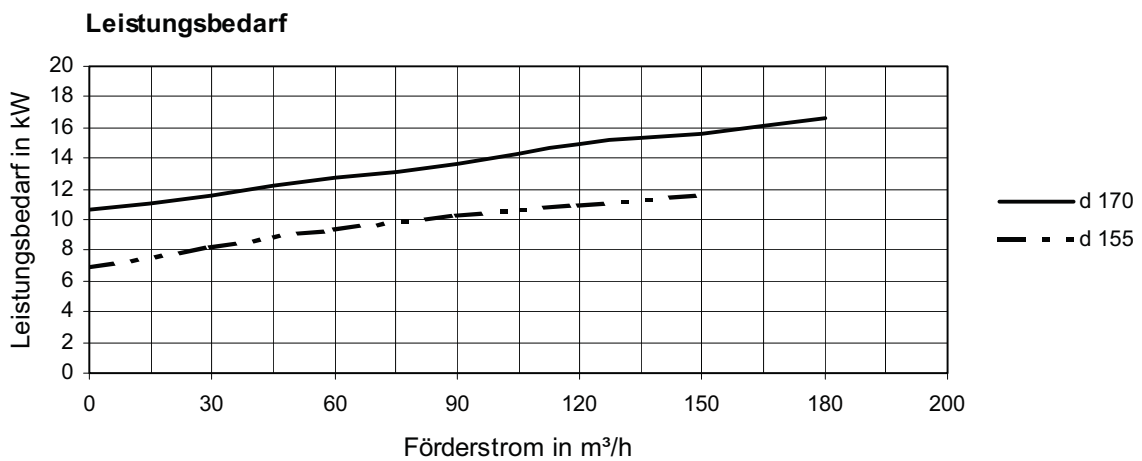
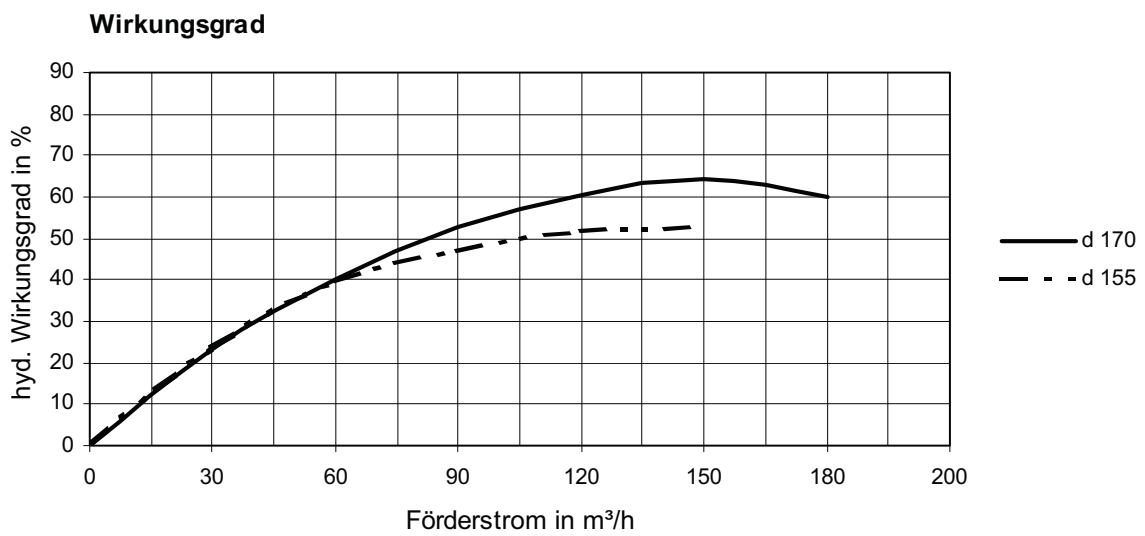
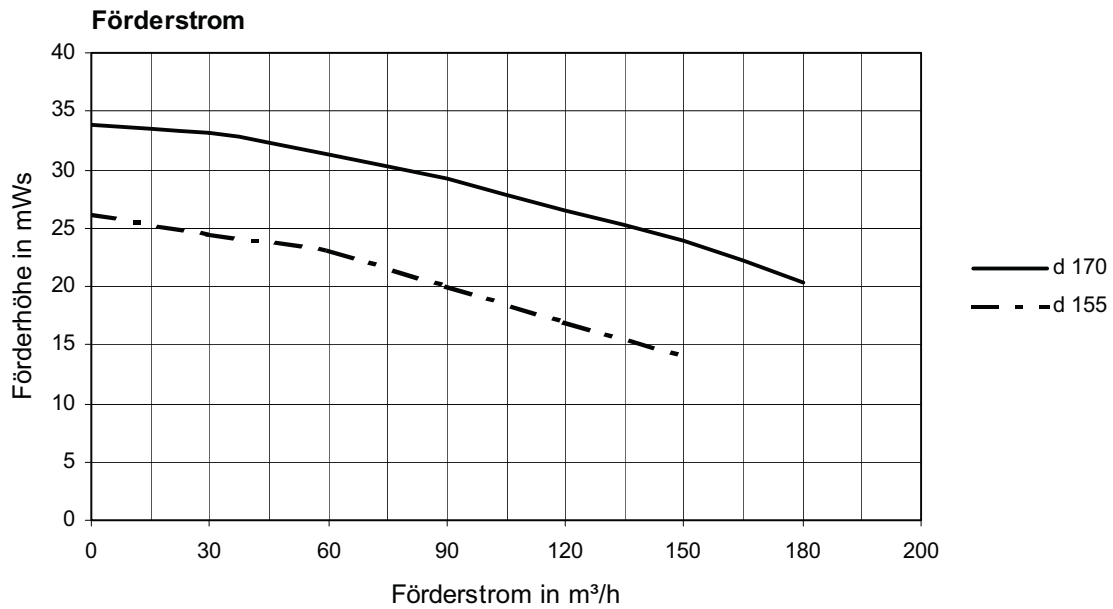

Chemie-Normpumpe N

Typ N 125 - 80 - 160

Motor kW: 5,5
Drehzahl: 1450

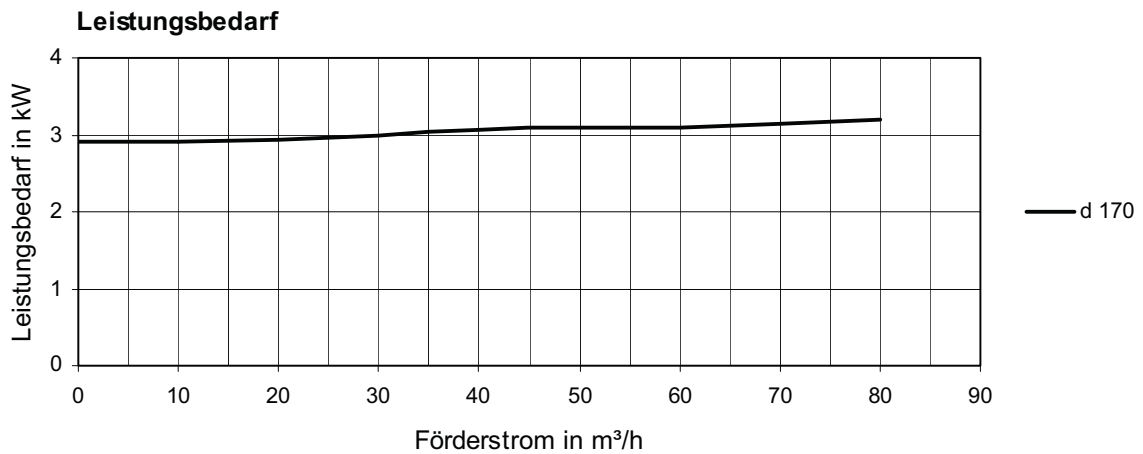
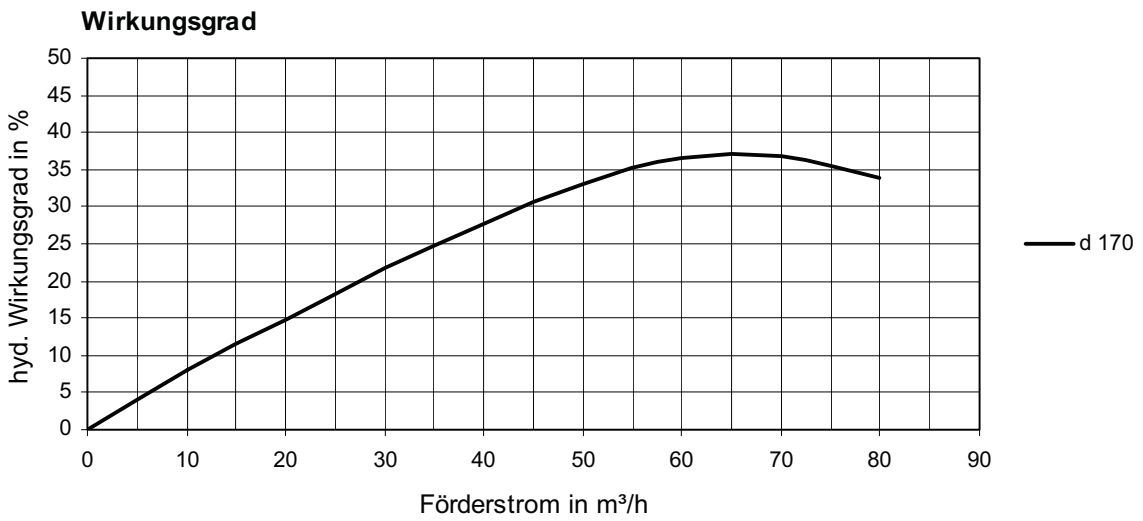
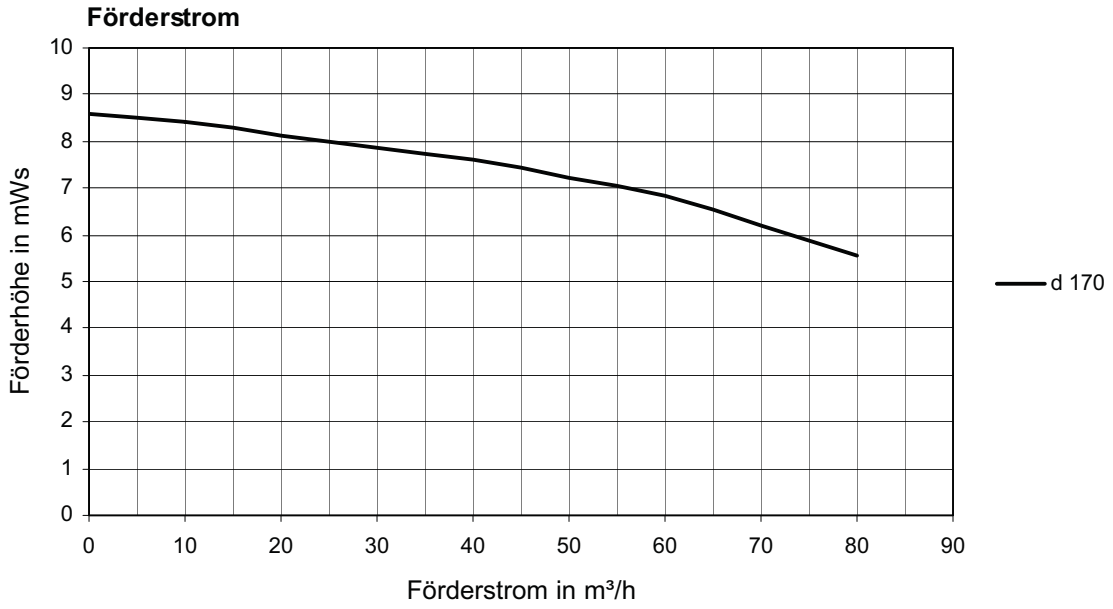

Chemie-Normpumpe N

Typ N 125 - 80 - 200

Motor kW: 30
Drehzahl: 2900

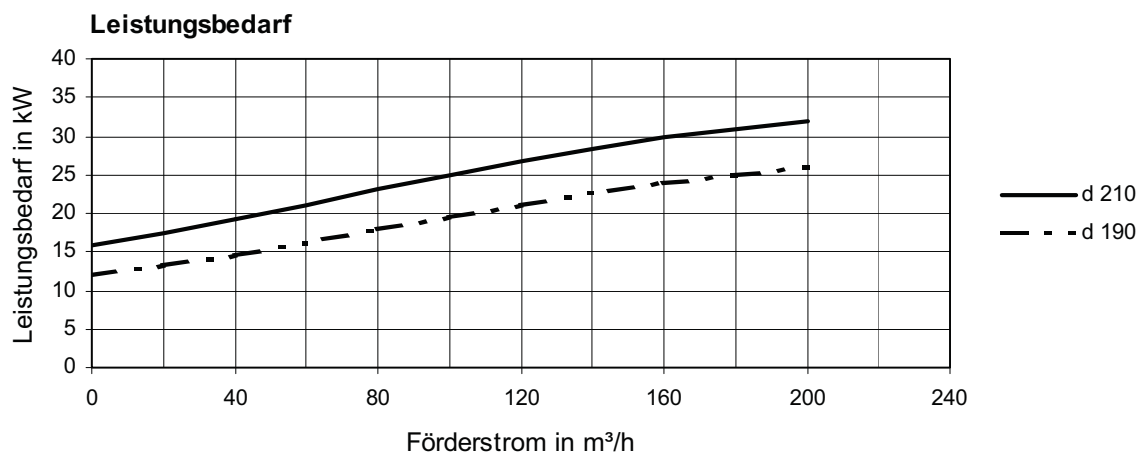
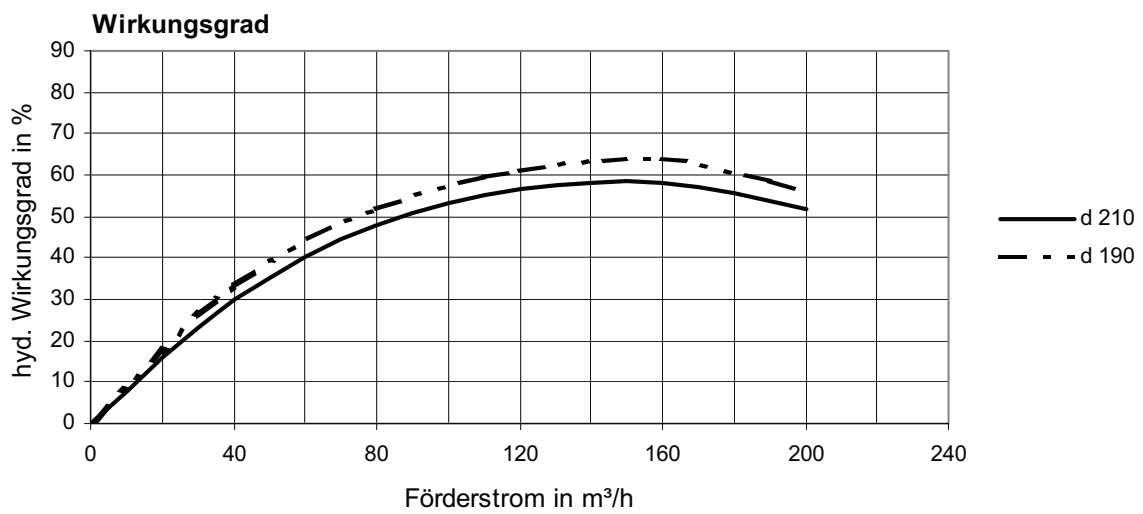
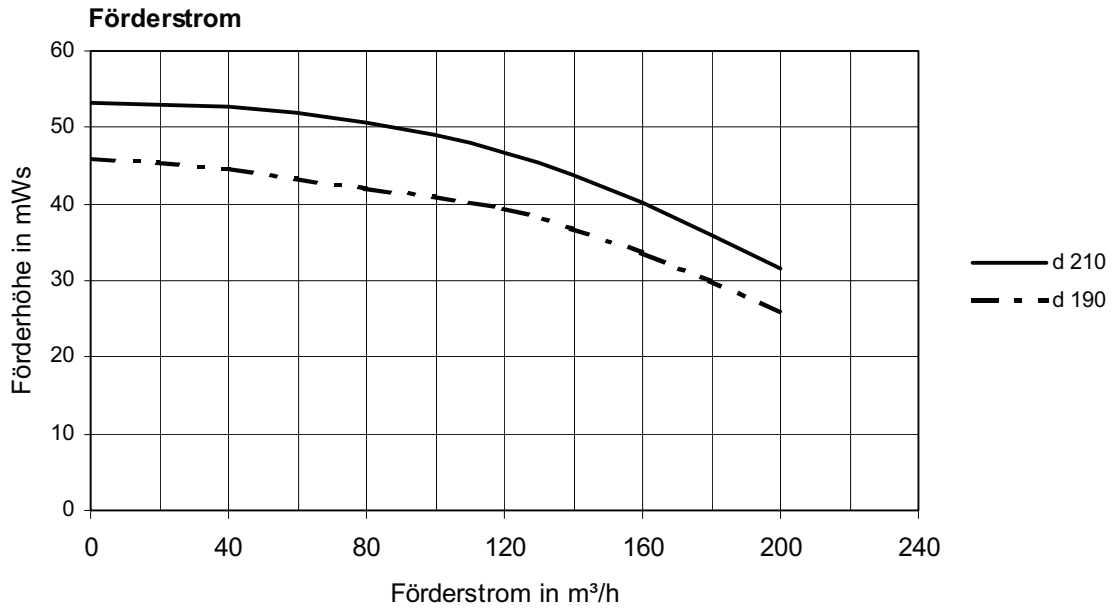

Typ N 125 - 80 - 200

Motor kW: 7,5
Drehzahl: 1450

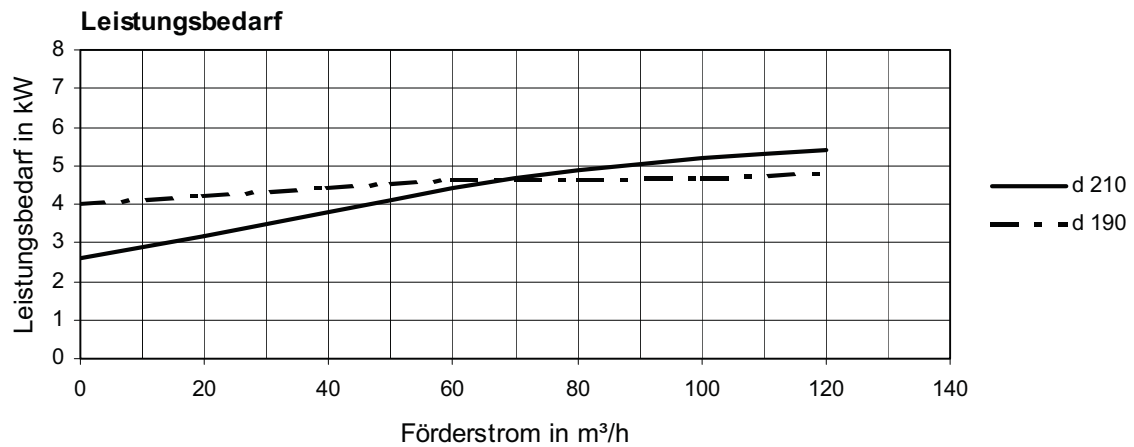
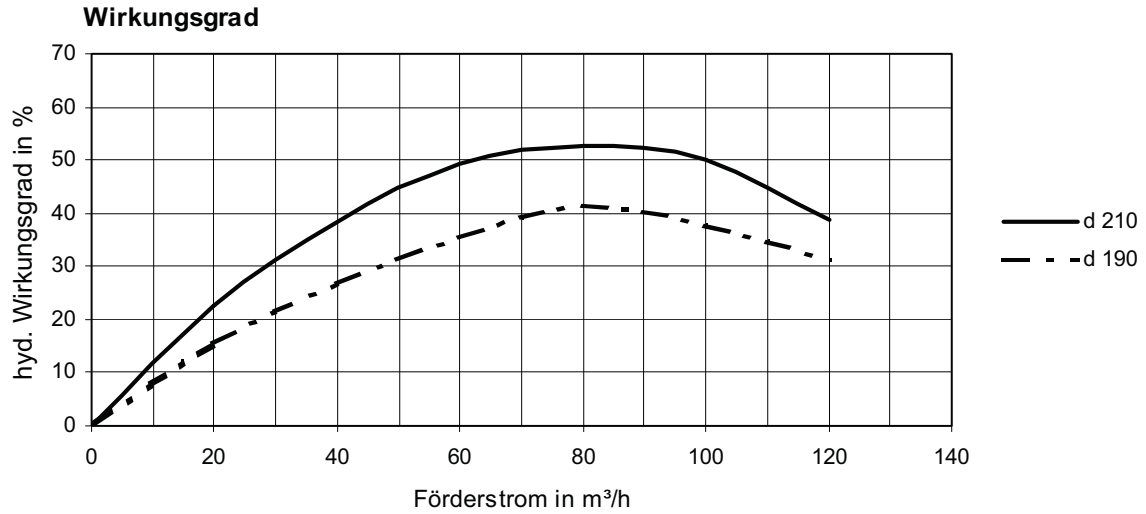
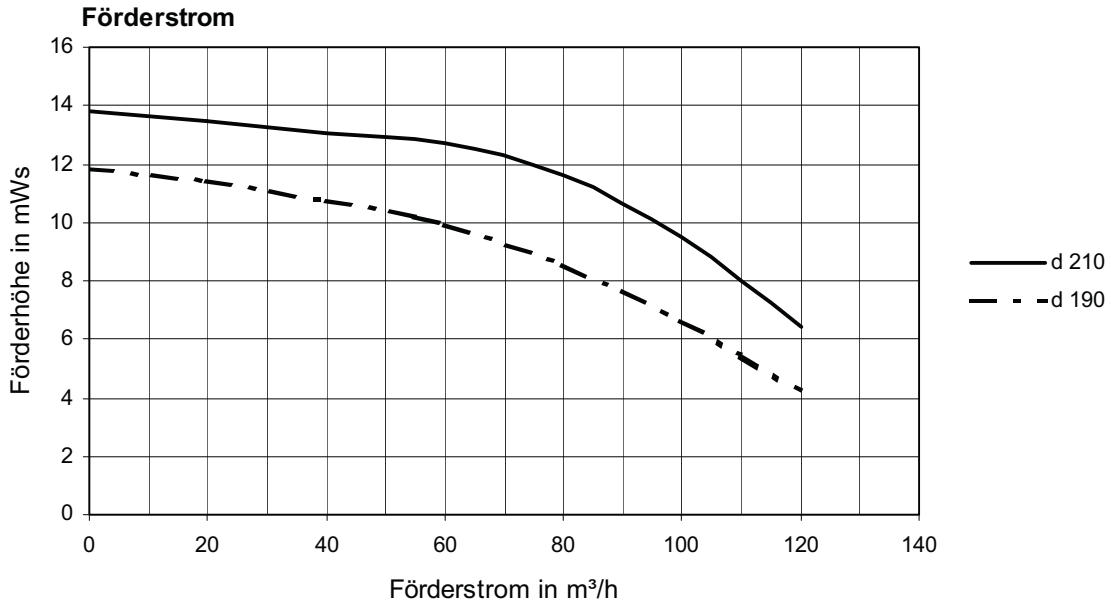

Typ N 125 - 80 - 250

Motor kW: 15
Drehzahl: 2900

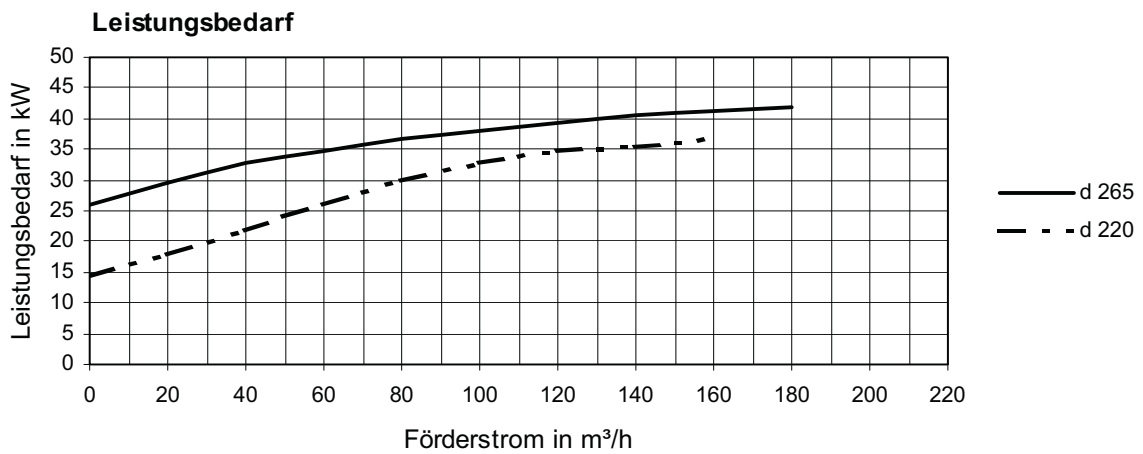
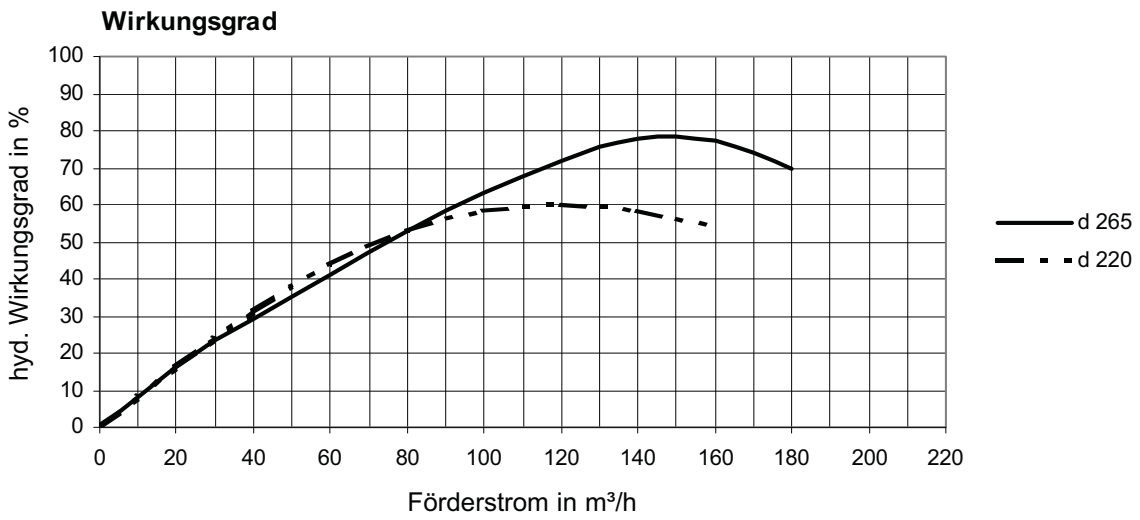
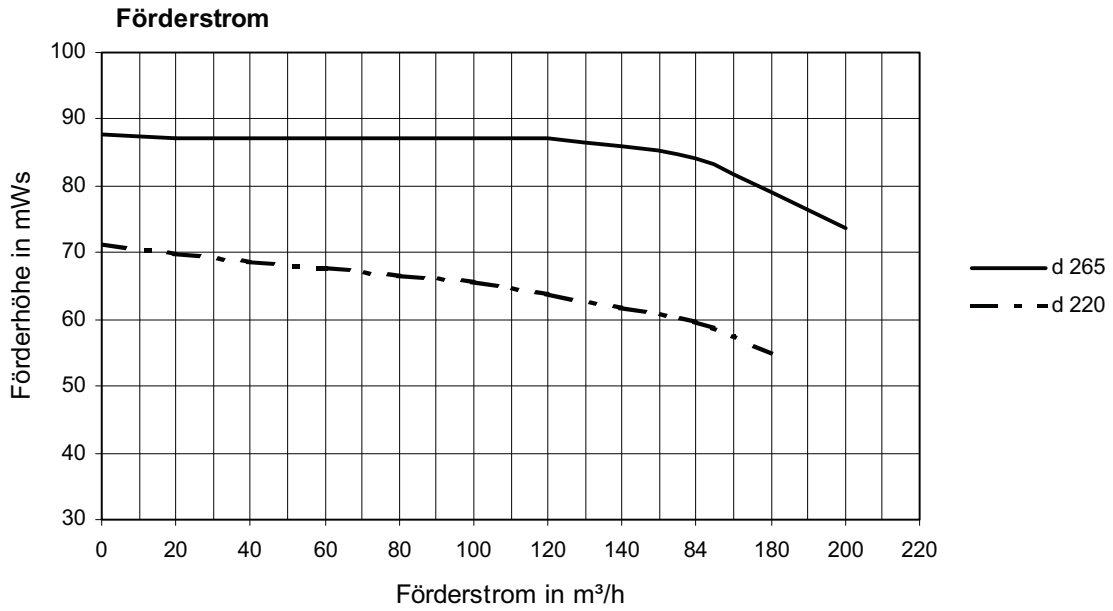

Chemie-Normpumpe N

Typ N 125 - 80 - 250

Motor kW: 11
Drehzahl: 1450

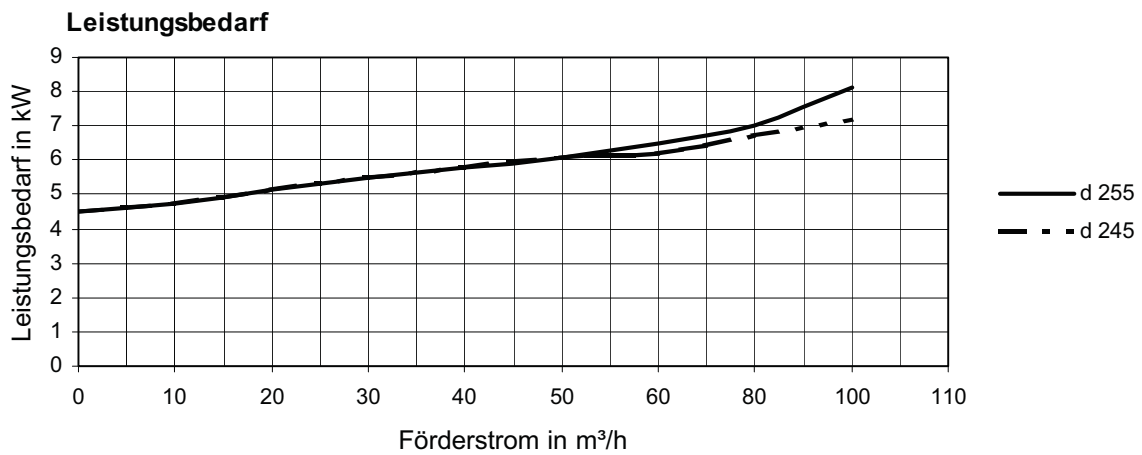
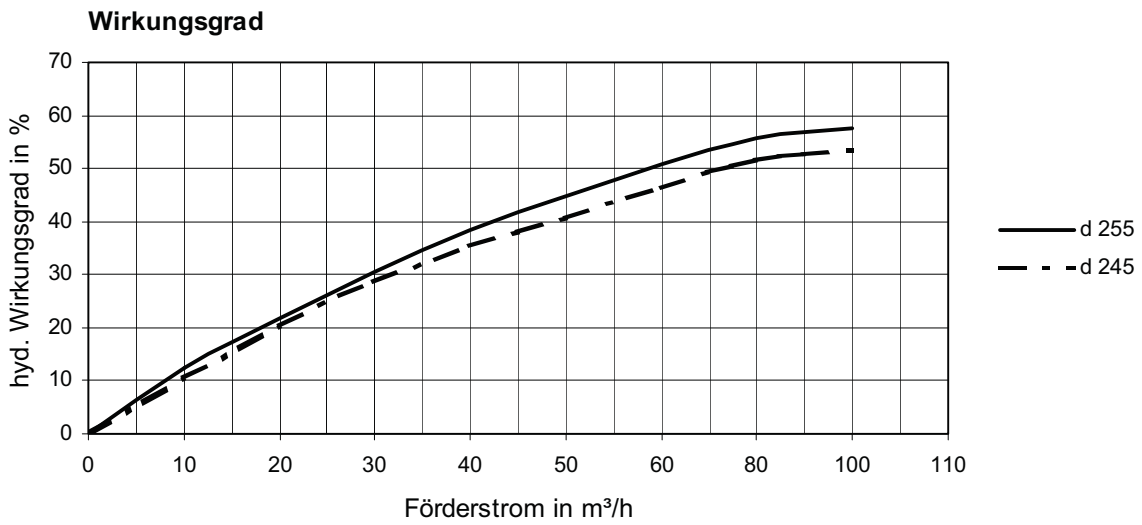
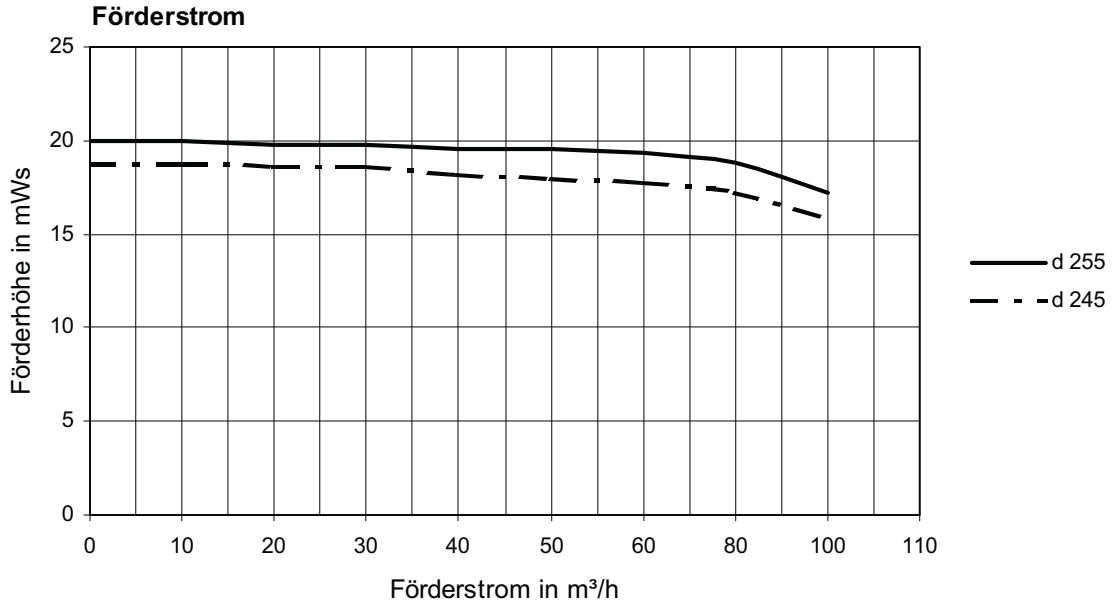

Chemie-Normpumpe N

Typ N 125 - 80 - 315

Motor kW: 20
Drehzahl: 1450

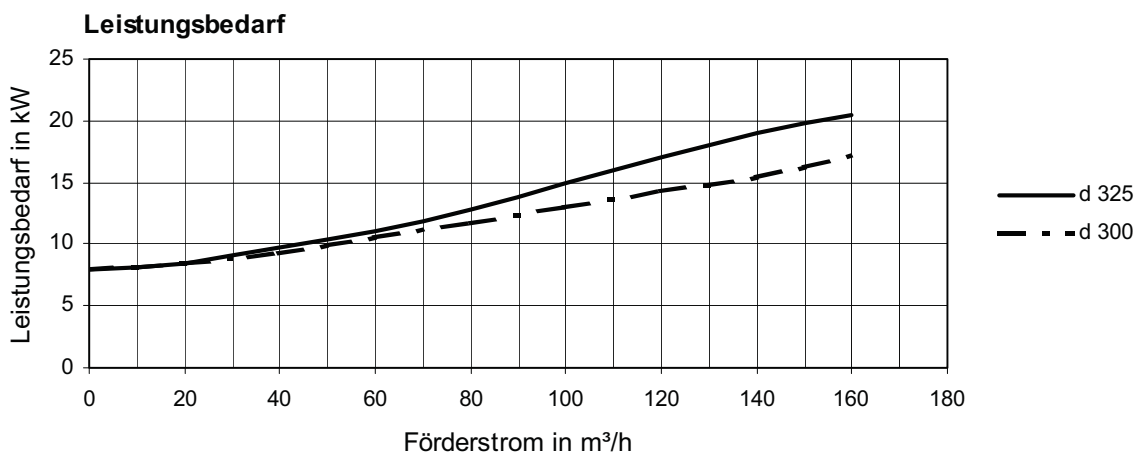
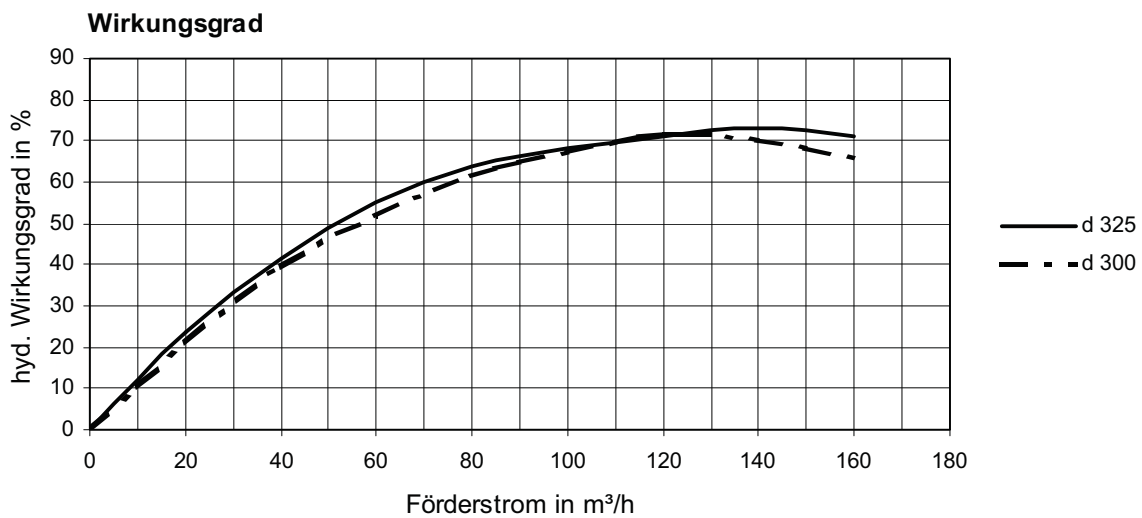
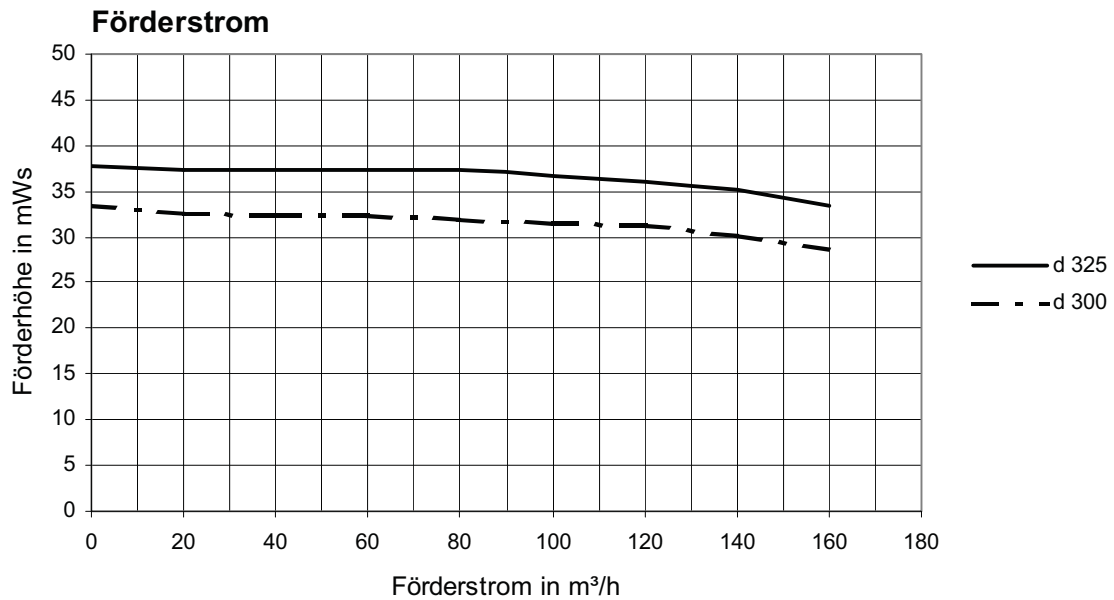

Chemie-Normpumpe N

Typ N 125 - 100 - 200

Motor kW: 5,5
Drehzahl: 1450

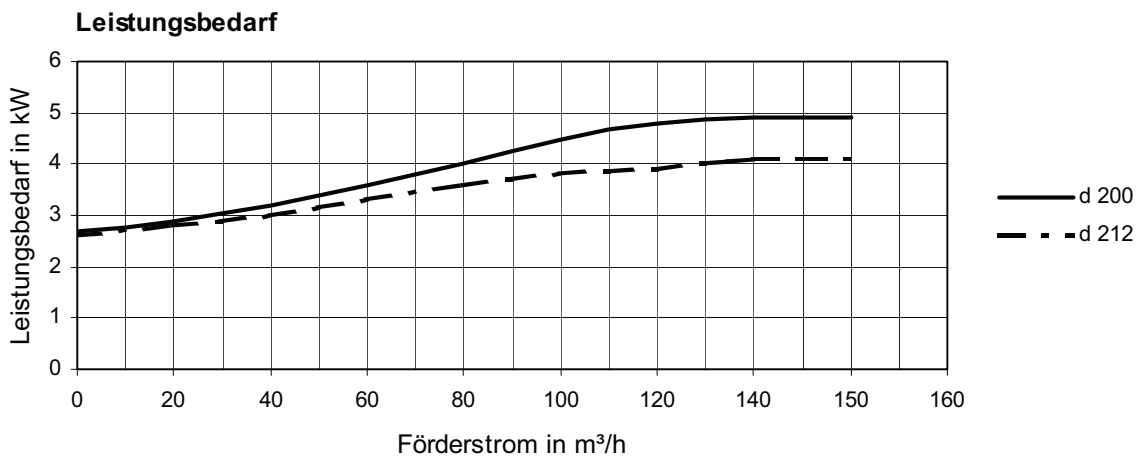
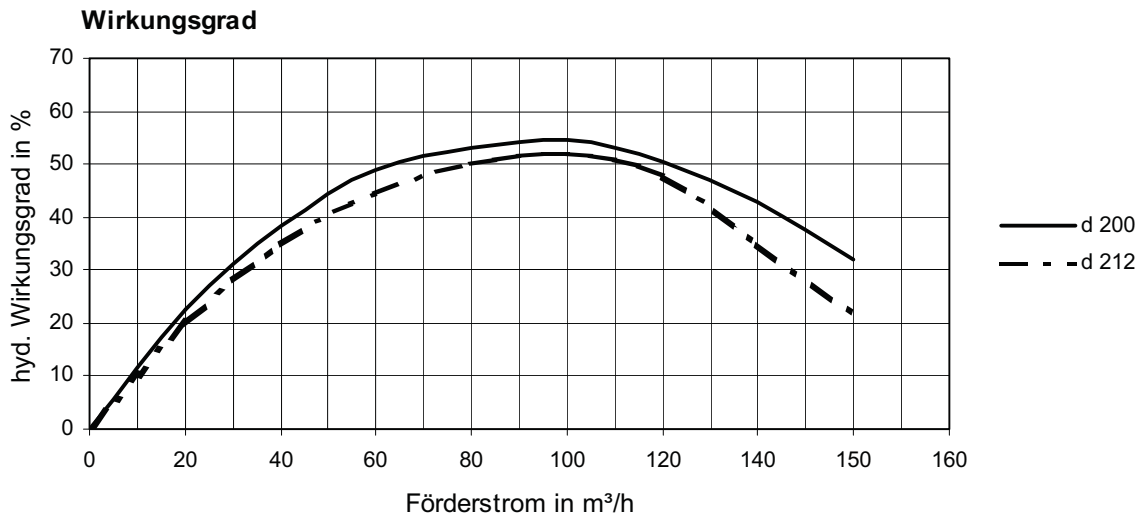
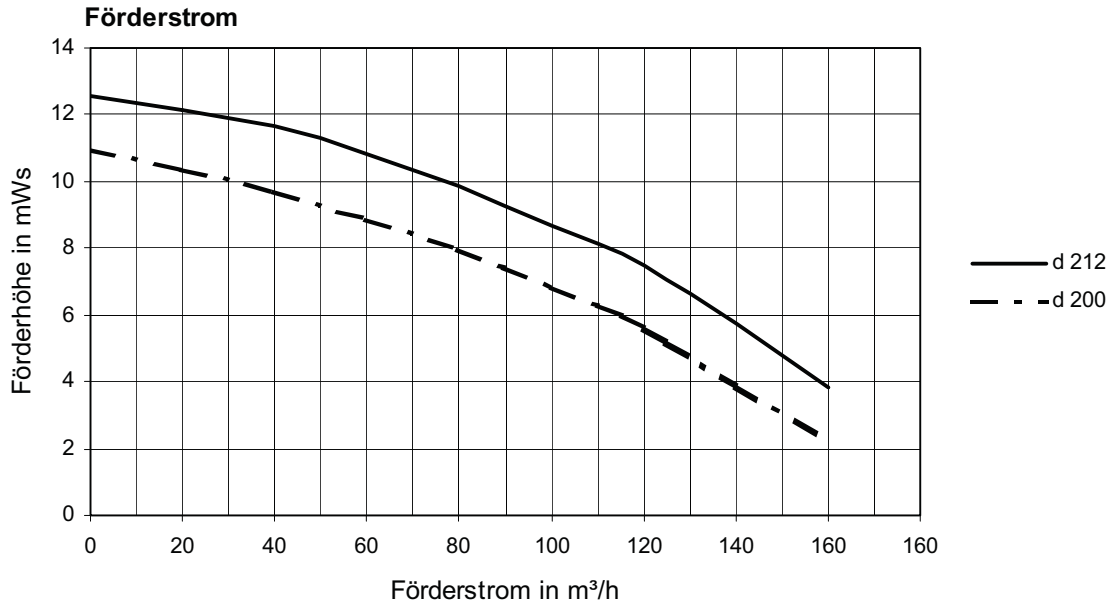

Chemie-Normpumpe N

Chemie-Normpumpe N

Typ N 125 - 100 - 250

Motor kW: 15
Drehzahl: 1450

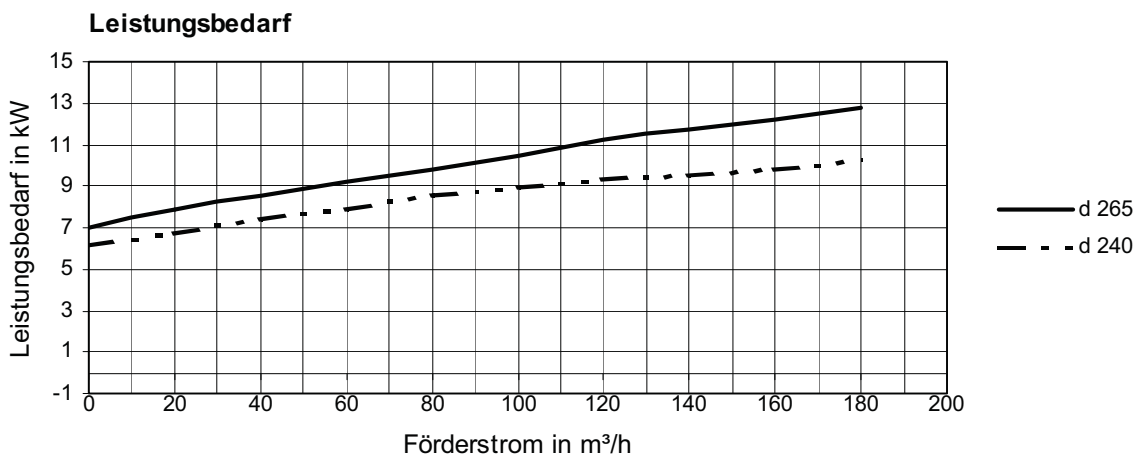
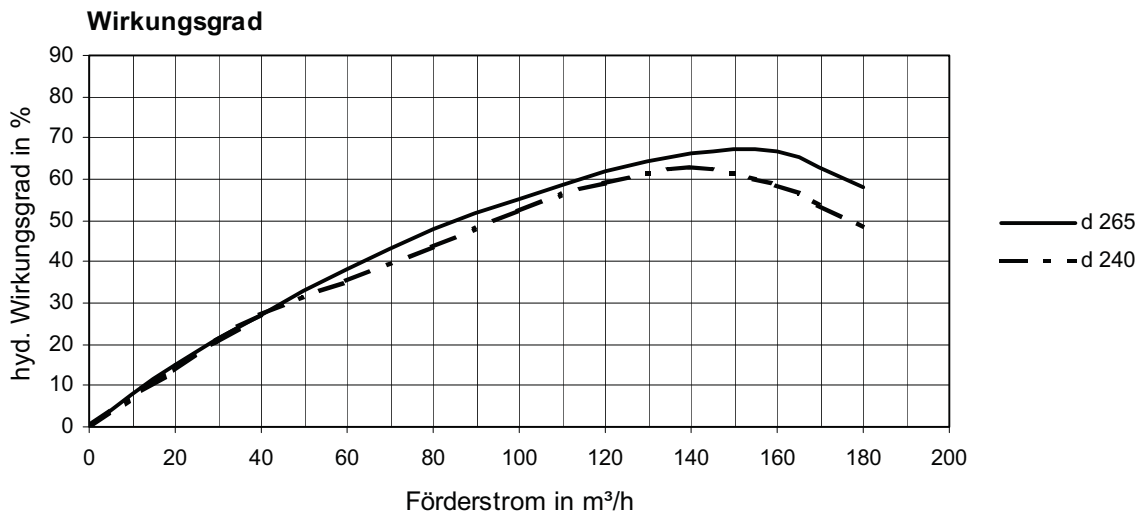
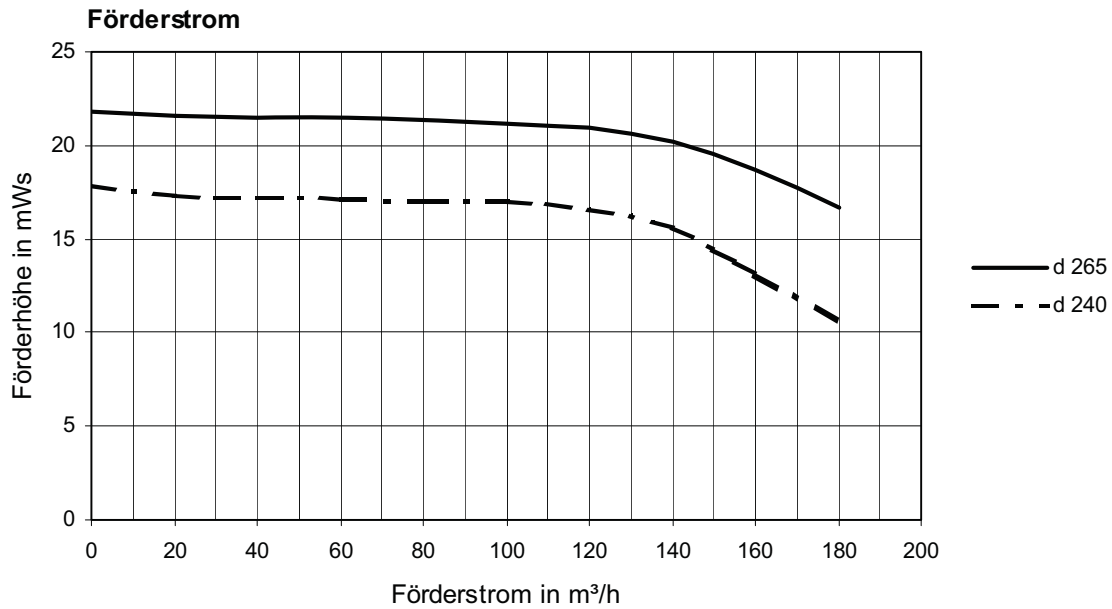

Chemie-Normpumpe N

Chemie-Normpumpe N

Typ N 125 - 100 - 315

Motor kW: 22
Drehzahl: 1450

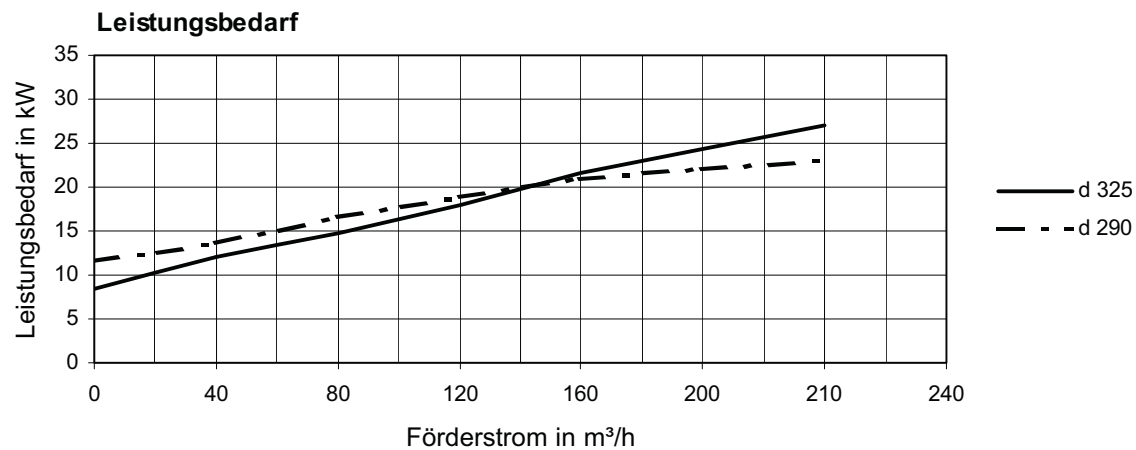
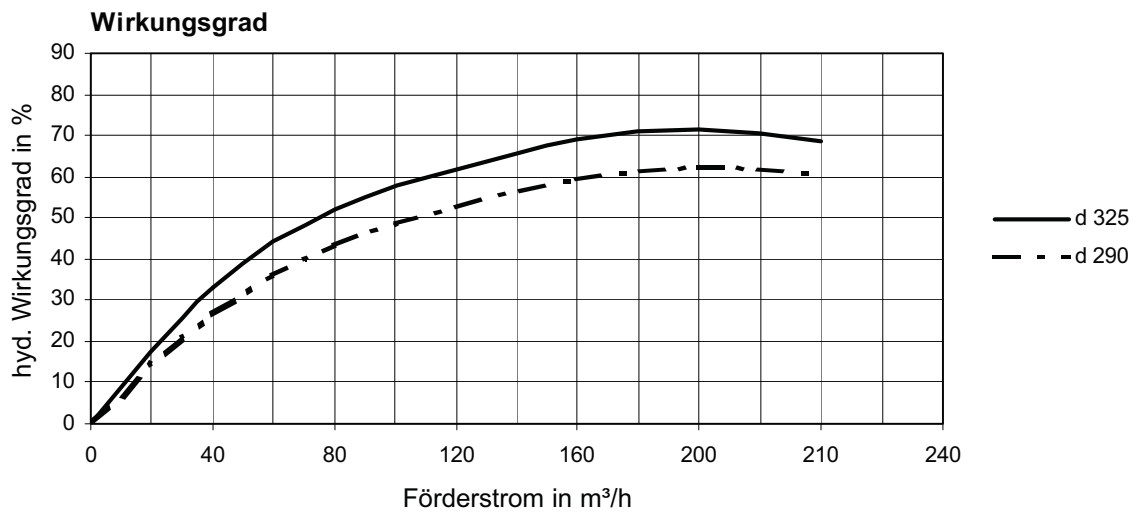
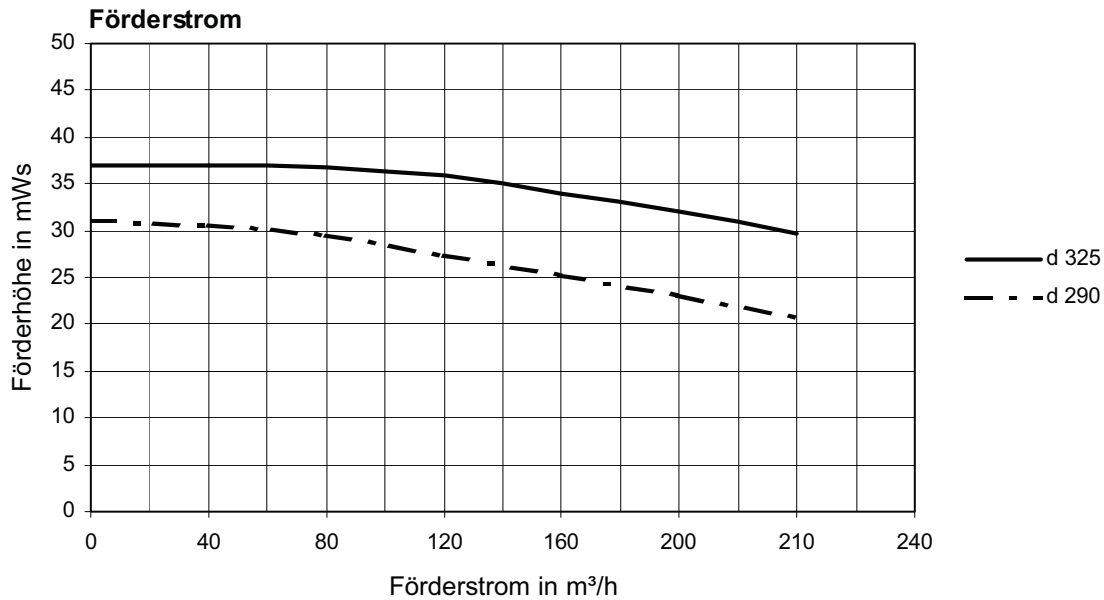

Chemie-Normpumpe N

Chemie-Normpumpe N

Typ N 150 - 125 - 250

Motor kW: 11
Drehzahl: 1450

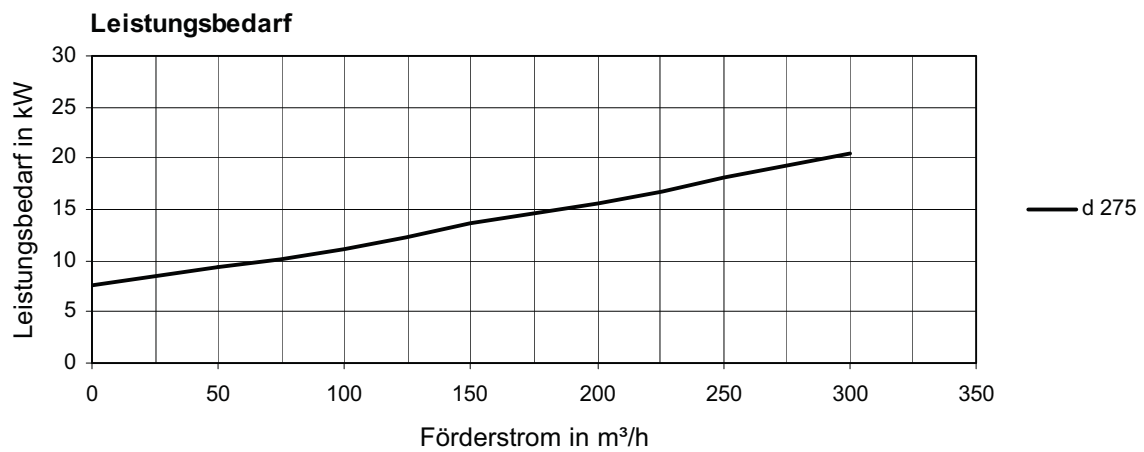
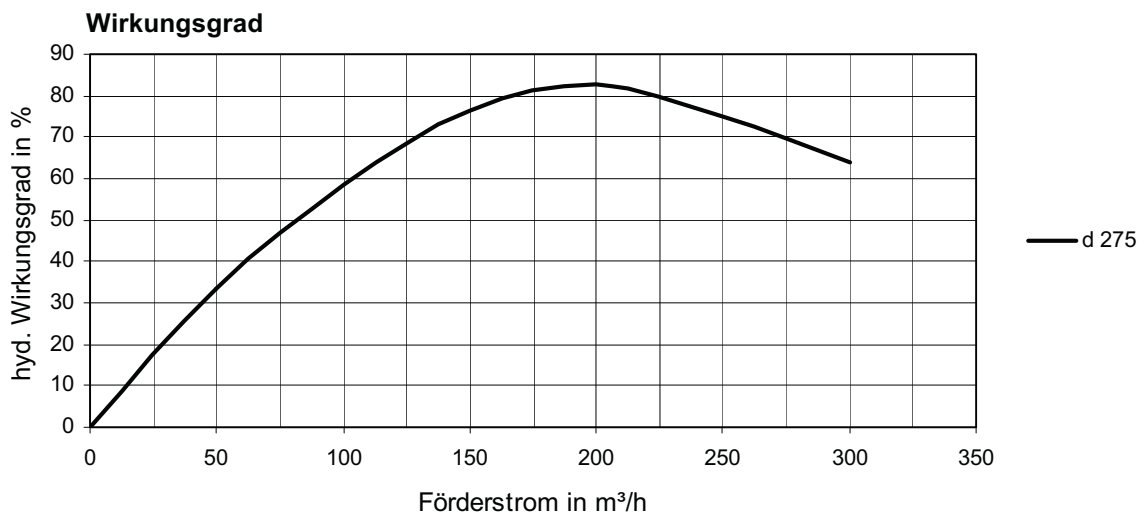
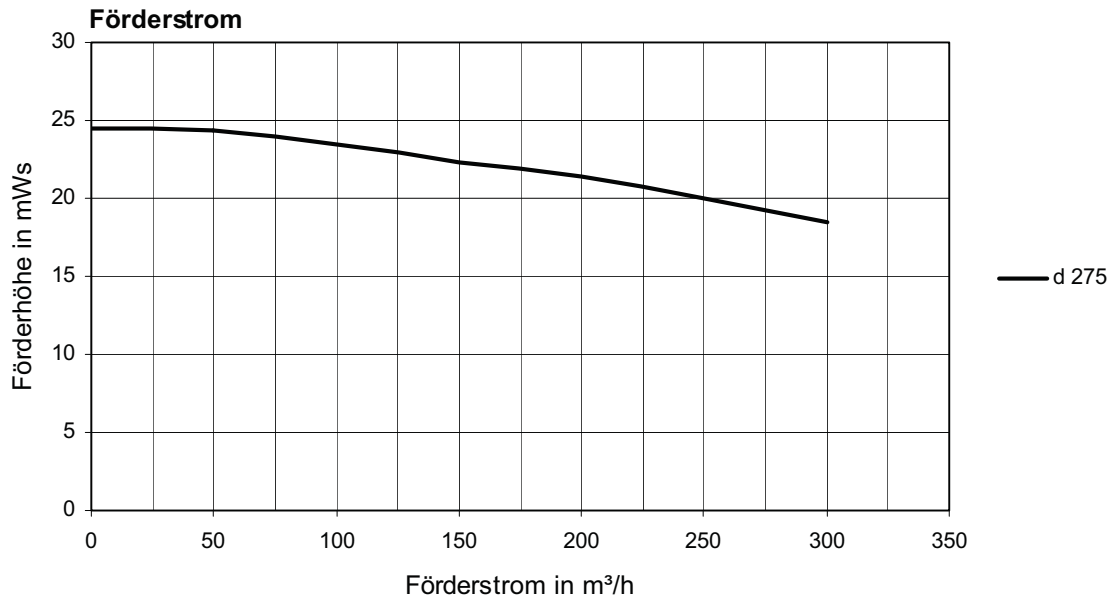

Chemie-Normpumpe N

Chemie-Normpumpe N

Typ N 200 - 150 - 250

Motor kW: 18,5
Drehzahl: 1450

